

Sterilization Container Systems



safe, secure, sterilized

Protecting Your Instruments Every Time

5 Different Models

 Different
Colors

 hermann
müller





Hermann Müller Medizintechnik GmbH has the right to modify and develop the products declared in this catalogue and its production program. The weight and dimensional information given in our catalog are approximate values.

Copyright © Hermann Müller Medizintechnik GmbH All Right Reserved, Printed in Türkiye

HM-KA3014 – Edition (08 / 2024)



**hermann
müller**

CONTENT

Page Numbers

STERILIZATION CONTAINERS

16 - 27	——	STANDARD PLUS MODEL
28 - 41	——	BIO-BARRIER MODEL
42 - 57	——	BARRIER 3 MODEL
58 - 65	——	WINDOW MODEL
66 - 73	——	PLASMA MODEL (H ₂ O ₂ for sterrad)
74 - 91	——	DENTAL, MINI, SPECIAL MODEL

BASKETS

92 - 99	——	PERFORATED TRAYS
100 - 106	——	WIRE BASKETS
107 - 109	——	ALUMINIUM BASKETS, WASHER TUBES FOR K-WIRES

ACCESSORIES

110 - 113	——	MODULAR AUTO LOCK MECHANISM
114 - 115	——	WINDOW FOR EMULATING INDICATOR
116 - 133	——	FILTERS, INDICATORS, FILTER FILTER RETAINER, SILICONE MATS, SECURITY SEAL, RACKS, RAILS, HOLDERS, DIVIDERS
134 - 138	——	INDEX



Deep Drawn
In 500 Tons

In Massive
Press Area

Shaped By
Professional
Hands

STERILIZATION CONTAINER SYSTEMS CUSTOM MADE PRODUCTS

We perform our customers' special production requests in a manner that does not violate international patent and intellectual property rights. In this way, we increase the flexibility and competitiveness of our valued customers.

We move our customers one step further; All of our products are branded and supplied with our company logo or your company logo by laser marking according to your request, depending on the OEM agreement.

Our products are marked, signed, numbered and adjusted according to your company's requirement. The products which are marked according to your company's requirement establish a strong, permanent bond in traceability and receive feedback between your company and your customers.

Grow Practice, Gain Happiness

Sterilization Container System



STERILIZATION CONTAINER SYSTEMS

Hermann Müller manufactures sterilization container systems in medical industry since 1988 and releases the quality that takes human health under best protection. Hermann Müller sterilization container systems are made of special alloy - 2mm high quality raw material and serviced to the whole world as 5 different models and 8 colors coding easy distinctiveness. The single block label holders on both sides of the containers also serve for that purpose while carrying handles having 90° mobility and ergonomic design provide easy and secure carrying facilities and the gasket inside the lid ensures perfect tightness.

Besides providing a greener alternative to wrapping method, Hermann Müller sterilization container systems also generate a great return on investment. Hermann Müller meets needs of the market and preferred by many users all over the world because of its high quality, reasonable prices and variety of products that appeal to every user.



WHY

STERILIZATION CONTAINER SYSTEMS

As you know, there are two general methods for the sterilization and protection of surgical instruments: single-use wrap and reusable sterilization container systems.

The main differences between these methods are efficiency and return on investment.

Return on Investment: The single-use wraps seem more economical at first view. They are single-use and disposable. However, these medical wastes are 5-10% of the total medical waste streams of hospitals. Furthermore, single-use wraps can tear during the sterilization process because of any reason. In this case, sterilization is performed again and this may cause many delays. The aluminum sterilization containers can be considered as non-economic at first view but the lifetime of them is more than 5 years. When the lifetime is based on, the total cost reduces approximately at a rate of 70-80% more when compared with the cost of single-use wraps and that's why they are more economical choice.

Environmental Awareness: The sterilization containers has a big role for the care that we need to take for our life space which is polluted more day by day. The sterilization containers do not cause any kind of medical waste streams and protect the environment.

Efficiency: You do not face with any tearing and containerization is a more effective method for the sterilization. In terms of following and detecting the sterilization period and result, It increases the efficiency with accessories like automatic lock, indicator window and security seal.

Reliability: They protect the surgical instruments in the maximum level with the help of their hard and sheltered structure.

Ease of Identification: Reaching the information of instruments inside the sterilization container is easier due to the face plate that sterilization containers have in both sides. Moreover, they provide ease of identification with the help of different lid color options creating color coding.

Safe Handling: They enable more proper, easier and safer transportation with their ergonomic design and handles.



K E E P E S A F E

E

E

P

S

T

E

R

I

L

E

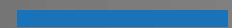
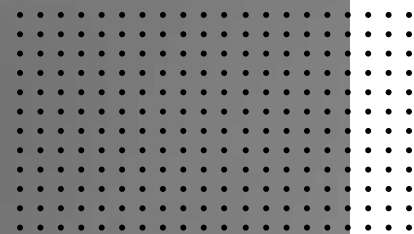

All Hermann Müller sterilization container systems are designed for perfect steam penetration, traceability, safety and stability. The locking mechanisms secure excellent grip and ensure up and down movement of the lids under steam pressure during the sterilization.

Standard Heights



110 mm

135 mm

150 mm

200 mm

260 mm

Standard Dimensions



TYPES

AND

DIMENSIONS

Hermann Müller sterilization container systems, with most general point of view, are separated into 5 different dimension groups as $\frac{1}{2}$, $\frac{3}{4}$, $1/1$, Extra Large and Extra Long models. Additionally, we can supply smaller models like Dental and Mini Sterilization Containers.



LID & BASE SPECS

In Sterilization Containers

Special lid design for stackability!

Sealed filter retainers having 2 springs inside and pre-tensioning feature enable fast, easy and secure change of the filters by seating solidly on the surface.

Optional OEM marking possibility!

Locking mechanism ensures better grip with its flexible design structure including 2 springs inside and performing "single-step" movement.

Heat sensitive modular auto lock mechanism offers safer result for sterilization process.



Internal gasket of the lid assures safe seal of the container.

Wide, special design, silicone coated handles let easy and safe handling of the container and avoids hand injuries. 8 different colors available.

Identification labels can be marked with up to 18 - 24 letters.

Optional OEM marking possibility!

Corrosion resistant lid and bottom made of 2 mm high quality special alloy aluminium!

Face plates on both sides of the container are made of one single piece !



Safety Lids



The safety lids provide impact protection and prevent contamination during both storage and transport.

8 Different Colours 

Perforated Lids

Perforated and Non-Perforated Container Options



Box (Perforated)



Box (Non Perforated)

SUITABILITY OF OUR STERILE CONTAINERS FOR STEAM STERILIZATION PROCEDURES ¹⁾
as per DIN 58953 part 9

Sterilization container	Packing		Steam sterilization procedure acc. to DIN 58946, part 1				
	Description	Symbolic representation and packing system	Gravitation procedure	Pre-vacuum procedure	Fractional vacuum procedure	Fractional flow procedure	Steam injection procedure
with filters (StB-F)	Textiles in sterilization container with filter in lid and bottom acc. to DIN 58952 part 1		+	+	+	+	+
			○	○	+	+	+
	Textiles in sterilization container with filter in lid, bottom not perforated acc.to DIN 58952 part 1		-	-	+	+	+
			-	-	+	+	○
	Textiles in sterilization container with filter in bottom lid,not perforated acc.to DIN 58952 part 1		○	+	+	+	+
			-	○	+	+	+
	Instruments in wire basket acc. to DIN 58952 part III, in sterilization container with filter in lid and bottom acc. to DIN 58952 part 1		+ ³⁾	+	+	+	+
	Instruments in wire basket acc. to DIN 58952 part III, in sterilization container with filter in lid and bottom not perforated acc. to DIN 58952 part 1		-	+ ²⁾	+ ²⁾	+ ²⁾	+ ²⁾
	Instruments in wire basket acc. to DIN 58952 part III, in sterilization container with filter in bottom acc. to DIN 58952 part 1		○	+	+	+	+
	with Valves (StB-V)	Textiles in sterilization container with valves in lid and bottom acc. to DIN 58952 part 1		-	○	+	+
			-	-	+	+	○
Textiles in sterilization container with valves in lid no valves on the bottom			-	-	+	+	-
			-	-	+	+	-
Instruments in wire basket in sterilization container with valve in lid and bottom			-	+ ²⁾	+ ²⁾	+ ²⁾	+ ²⁾
Instruments in wire basket in sterilization container with valve in lid and not perforated			-	+ ²⁾	+ ²⁾	+ ²⁾	+ ²⁾

Explanation of symbols:

+ applicable

- not applicable

○ limited application

- 1) In order to avoid mistakes with regards to service, operation and/or when loading the sterilizer, please refer to table 1 for correct or wrong combination of sterilization containers for standardized steam sterilization procedures.
- 2) Only sterilization containers guaranteeing evaporation or discharge of condensate are suitable above.
- 3) Gravitation procedures having no drying device do not guarantee a sufficient after-drying effect.

What We Offer?

Solution

Product range for sterile instrument processing of Hermann Müller offers sterilization, transportation and storage solution with different filtering systems for all hospital and clinic instrument sets used in surgery rooms. By providing many different sizes and complementary accessories Hermann Müller provides a universal solution for sterilization supply of CSSDs.



STANDARD PLUS

STERILIZATION CONTAINER SYSTEMS



The Standard + containers are the latest product model of the container systems range, with the improved design details presented to the market by Hermann Müller. This model, which is produced with stable and robust boxes and covers, is also offered to customers with a total of 8 different color coding options, with 2 new colors added. This container model can be used with both a disposable paper filter and 2000 cycle PTFE Teflon filter. The model, which supports all additional features such as modular auto lock supported by previous models, is available in 5 different sizes. The carrying handles have a 90° mobility capability, but can also be ordered with 8 different colors of silicone coating.

The locking mechanism made of aluminum has a spring system and can offer more flexibility and grip performance. Boxes and covers are produced with 2 mm thick special alloy aluminum. The boxes can be ordered with or without perforation. The safety lids which are second cover for effective external protection, are also available for 3 main sizes.

Box Types

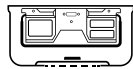

Box (Perforated)

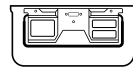

Box (Non Perforated)

Standard Heights



110 mm

135 mm

150 mm

200 mm

260 mm



Dimensions



1/2 Half Size

Page 22 -23

3/4 Quarter Size

Page 20 -21

1/1 Full Size

Page 18 -19

Extra Large Size

Page 24 -25

Extra Long Size

Page 26 -27

STANDARD PLUS

STERILIZATION CONTAINER SYSTEMS

1/1 Full Size

Box Types

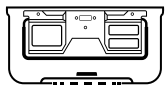

Box (Perforated)

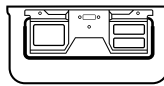

Box (Non Perforated)



Box (Non Perforated)



Code	Outside Dimension	Inside Dimension	Weight
K6-105	600 x 272 x 96 mm	543 x 258 x 90 mm	1945 g
K6-106	600 x 272 x 116 mm	543 x 258 x 110 mm	2100 g
K6-107	600 x 272 x 138 mm	543 x 258 x 132 mm	2255 g
K6-108	600 x 272 x 190 mm	543 x 258 x 184 mm	2655 g
K6-109	600 x 272 x 235 mm	543 x 258 x 229 mm	3100 g



Box (Perforated)



Code	Outside Dimension	Inside Dimension	Weight
K6-100	600 x 272 x 96 mm	543 x 258 x 78 mm	2200 g
K6-101	600 x 272 x 116 mm	543 x 258 x 99 mm	2360 g
K6-102	600 x 272 x 138 mm	543 x 258 x 121 mm	2520 g
K6-103	600 x 272 x 190 mm	543 x 258 x 173 mm	2975 g
K6-104	600 x 272 x 235 mm	543 x 258 x 218 mm	3355 g



8 Different Colours

Perforated Lids

Dimension 585 x 285 mm
Weight 1395 g



Color	Code
Grey	K6-3120
Yellow	K6-3121
Green	K6-3122
Blue	K6-3123
Red	K6-3124
Black	K6-3125
Purple	K6-3126
Bronze	K6-3127

Removal Lids

Dimension 585 x 285 mm
Weight 1271 g



Color	Code
Grey	K6-3130
Yellow	K6-3131
Green	K6-3132
Blue	K6-3133
Red	K6-3134
Black	K6-3135
Purple	K6-3128
Bronze	K6-3129

Safety Lids

Dimension 606 x 288 mm
Weight 1175 g



Color	Code
Grey	K6-3230
Yellow	K6-3231
Green	K6-3232
Blue	K6-3233
Red	K6-3234
Black	K6-3235
Purple	K6-3236
Bronze	K6-3237

STANDARD PLUS

STERILIZATION CONTAINER SYSTEMS

3/4 Quarter Size

Box Types

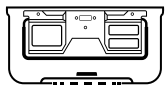

Box (Perforated)

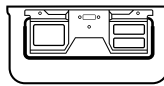

Box (Non Perforated)



Code	Outside Dimension	Inside Dimension	Weight
K6-305	475 x 272 x 96 mm	422 x 258 x 90 mm	1670 g
K6-306	475 x 272 x 116 mm	422 x 258 x 110 mm	1760 g
K6-307	475 x 272 x 138 mm	422 x 258 x 132 mm	1895 g
K6-308	475 x 272 x 185 mm	422 x 258 x 179 mm	2350 g

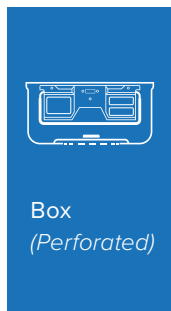

Code	Outside Dimension	Inside Dimension	Weight
K6-300	475 x 272 x 96 mm	422 x 258 x 78 mm	1795 g
K6-301	475 x 272 x 116 mm	422 x 258 x 99 mm	1885 g
K6-302	475 x 272 x 138 mm	422 x 258 x 121 mm	2020 g
K6-303	475 x 272 x 185 mm	422 x 258 x 168 mm	2475 g



8 Different Colours

Perforated Lids

Dimension 460 x 285 mm
Weight 1060 g



Color	Code
Grey	K6-3340
Yellow	K6-3341
Green	K6-3342
Blue	K6-3343
Red	K6-3344
Black	K6-3345
Purple	K6-3346
Bronze	K6-3347

Removal Lids

Dimension 460 x 285 mm
Weight 988 g



Color	Code
Grey	K6-3320
Yellow	K6-3321
Green	K6-3322
Blue	K6-3323
Red	K6-3324
Black	K6-3325
Purple	K6-3348
Bronze	K6-3349

Safety Lids

Dimension 483 x 290 mm
Weight 913 g



Color	Code
Grey	K6-3410
Yellow	K6-3411
Green	K6-3412
Blue	K6-3413
Red	K6-3414
Black	K6-3415
Purple	K6-3416
Bronze	K6-3417

STANDARD PLUS

STERILIZATION CONTAINER SYSTEMS

1/2 Half Size

Box Types

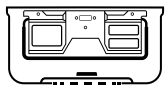

Box (Perforated)

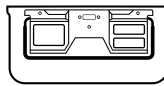

Box (Non Perforated)



Box (Non Perforated)



Code	Outside Dimension	Inside Dimension	Weight
K6-605	310 x 272 x 96 mm	253 x 258 x 90 mm	1285 g
K6-606	310 x 272 x 116 mm	253 x 258 x 110 mm	1345 g
K6-607	310 x 272 x 138 mm	253 x 258 x 132 mm	1455 g
K6-608	310 x 272 x 185 mm	253 x 258 x 179 mm	1705 g
K6-609	310 x 272 x 235 mm	253 x 258 x 229 mm	1955 g



Box (Perforated)



Code	Outside Dimension	Inside Dimension	Weight
K6-600	310 x 272 x 96 mm	253 x 258 x 78 mm	1400 g
K6-601	310 x 272 x 116 mm	253 x 258 x 99 mm	1460 g
K6-602	310 x 272 x 138 mm	253 x 258 x 121 mm	1570 g
K6-603	310 x 272 x 185 mm	253 x 258 x 167 mm	1820 g
K6-604	310 x 272 x 235 mm	253 x 258 x 218 mm	2070 g



8 Different Colours

Perforated Lids

Dimension 295 x 280 mm
Weight 775 g



Color	Code
Grey	K6-3630
Yellow	K6-3631
Green	K6-3632
Blue	K6-3633
Red	K6-3634
Black	K6-3635
Purple	K6-3636
Bronze	K6-3637

Removal Lids

Dimension 295 x 280 mm
Weight 667 g



Color	Code
Grey	K6-3620
Yellow	K6-3621
Green	K6-3622
Blue	K6-3623
Red	K6-3624
Black	K6-3625
Purple	K6-3638
Bronze	K6-3639

Safety Lids

Dimension 317 x 285 mm
Weight 659 g



Color	Code
Grey	K6-3700
Yellow	K6-3701
Green	K6-3702
Blue	K6-3703
Red	K6-3704
Black	K6-3705
Purple	K6-3706
Bronze	K6-3707

STANDARD PLUS

STERILIZATION CONTAINER SYSTEMS

Extra Large Size

Box Types

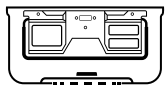

Box (Perforated)

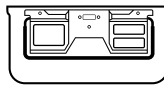

Box (Non Perforated)



Box (Non Perforated)



Code	Outside Dimension	Inside Dimension	Weight
K6-402	600 x 365 x 105 mm	543 x 350 x 99 mm	2365 g
K6-403	600 x 365 x 167 mm	543 x 350 x 161 mm	2890 g



Box (Perforated)



Code	Outside Dimension	Inside Dimension	Weight
K6-400	600 x 365 x 105 mm	543 x 350 x 88 mm	2620 g
K6-401	600 x 365 x 167 mm	543 x 350 x 150 mm	3145 g



8 Different Colours 

Perforated Lids

Dimension	Weight
583 x 370 mm	1675 g



Color	Code
Grey	K6-3326
Yellow	K6-3327
Green	K6-3328
Blue	K6-3329
Red	K6-3330
Black	K6-3331
Purple	K6-3315
Bronze	K6-3316

Removal Lids

Dimension	Weight
583 x 370 mm	1405 g



Color	Code
Grey	K6-3332
Yellow	K6-3333
Green	K6-3334
Blue	K6-3335
Red	K6-3336
Black	K6-3337
Purple	K6-3338
Bronze	K6-3339

STANDARD PLUS

STERILIZATION CONTAINER SYSTEMS

Extra Long Size

Box Types

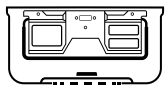

Box (Perforated)

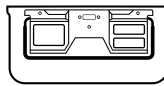

Box (Non Perforated)



Box (Non Perforated)



Code	Outside Dimension	Inside Dimension	Weight
K6-2005	725 x 275 x 127 mm	670 x 260 x 121 mm	2446 g
K6-2007	725 x 275 x 134 mm	670 x 260 x 128 mm	2503 g
K6-2006	725 x 275 x 191 mm	670 x 260 x 185 mm	2974 g



Box (Perforated)



Code	Outside Dimension	Inside Dimension	Weight
K6-2000	725 x 275 x 127 mm	670 x 260 x 110 mm	2700 g
K6-2002	725 x 275 x 134 mm	670 x 260 x 117 mm	2792 g
K6-2001	725 x 275 x 191 mm	670 x 260 x 173 mm	3230 g











8 Different Colours 

Perforated Lids

Dimension	Weight
710 x 285 mm	1572 g









Color	Code
 Grey	K6-3370
 Yellow	K6-3371
 Green	K6-3372
 Blue	K6-3373
 Red	K6-3374
 Black	K6-3375
 Purple	K6-3376
 Bronze	K6-3377

Removal Lids

Dimension	Weight
710 x 285 mm	1287 g



Color	Code
 Grey	K6-3380
 Yellow	K6-3381
 Green	K6-3382
 Blue	K6-3383
 Red	K6-3384
 Black	K6-3385
 Purple	K6-3386
 Bronze	K6-3387

BIO BARRIER

STERILIZATION CONTAINER SYSTEMS



Hermann Müller Bio-Barrier model sterilization container systems are designed with mechanical valves both in bottom and lid which run in a way that they do not need any disposable filter use and can be used minimum 5000 cycles. The mechanical valve systems set on the lid or box run with atmospheric pressure occurring in the autoclave during sterilization. When the sterilization process starts, because of the occurring (+) pressure, the valves open and let the steam penetration into the sterilization container. When the vacuum process starts at the end of the sterilization, because of the occurring (-) pressure, the steam outlet valve opens and the steam exhausts from the box. When the sterilization process is completed, as there is no pressure (+ or -) in autoclave, both valves are in closed position. By this way, it gains qualification to keep the products in it as sterilized. The valves are ensured to be closed %100 due to the special silicone gaskets on mechanical valve systems. Moreover, the mechanical valve system these sterilization containers is demountable by the user in order to control it when desired.

Hermann Müller Bio-Barrier model sterilization container systems are manufactured as five different lengths, width and height and can be supplied with safety lids for effective external protection. These safety lids do not interfere with sterilization and they provide protection to the valve mechanism against liquids and dust as a second lid. All models and sizes have specific baskets and accessories which can be viewed in following parts. Modular auto lock mechanism (thermo-lock) promising sterility assurance and indicator window providing visibility of the indicator card result by visual control without opening the lid are also available for this sterilization container model.

Box Types

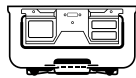

Box (With Barrier)

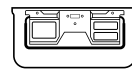

Box (Non Perforated)

Standard Heights



110 mm

135 mm

150 mm

200 mm

260 mm



Dimensions



1/2 Half Size

3/4 Quarter Size

1/1 Full Size

Extra Large Size

Extra Long Size

| Page 36 -37 |

| Page 34 -35 |

| Page 32 -33 |

| Page 38 -39 |

| Page 40 -41 |



Barrier Mechanism Parts

Barrier model containers are composed of a “mechanical filtering system”. The valves inside this filtering system have three different positions during the sterilization cycle which are called relax position, pre-sterilization and post-sterilization. It can be used at least 5000 cycles.



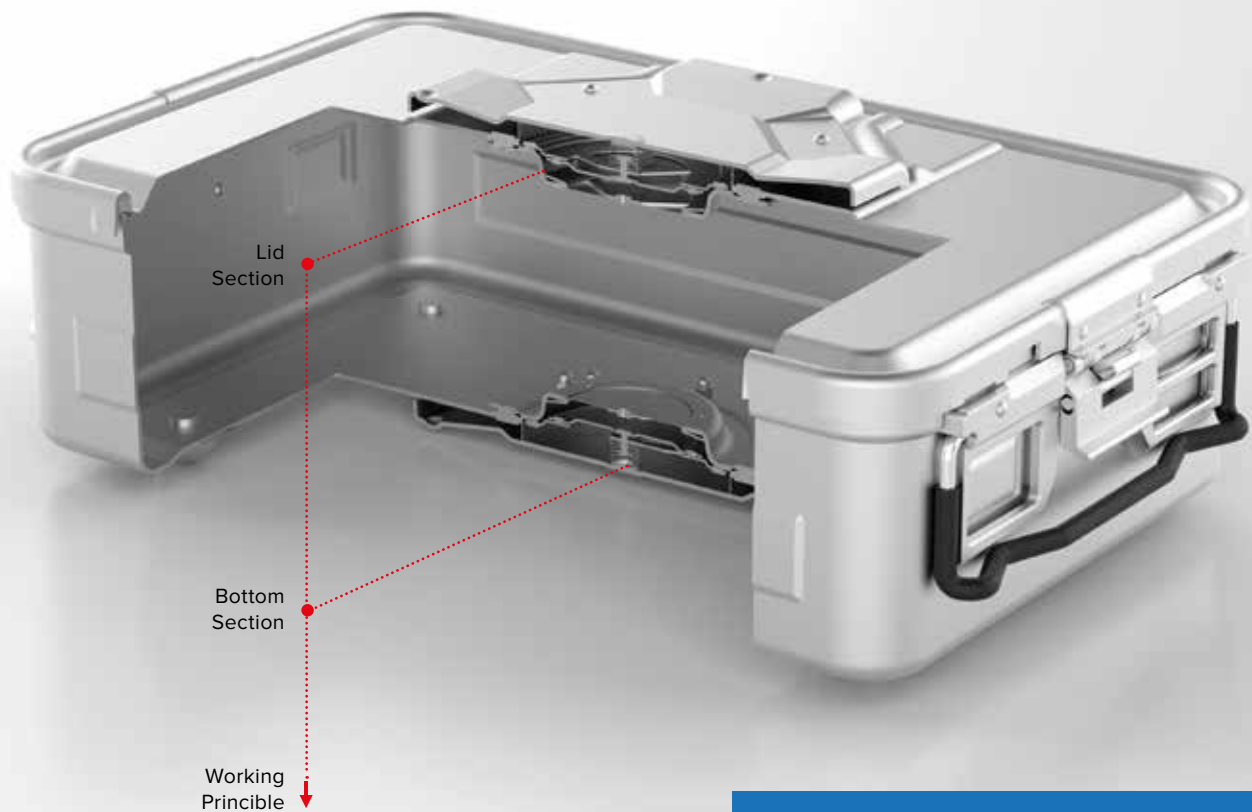

Cross section of mechanism & Working Principles

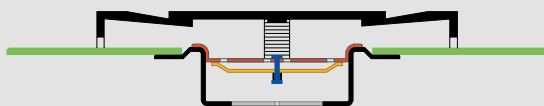

Before sterilization cycle the valves of the Barrier Model Container are closed and in relax position.

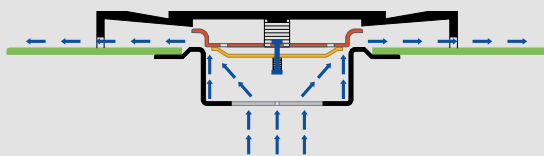

At the beginning of the sterilization cycle, by the effect of vacuum the valves are opened completely and dry air goes out of the container.

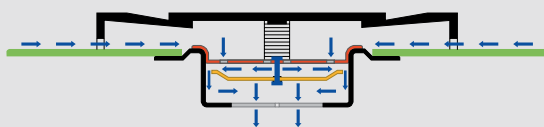

During the sterilization cycle the valves are opened with effect of pressure in the reverse way totally opposite of the way moved by the effect of vacuum.

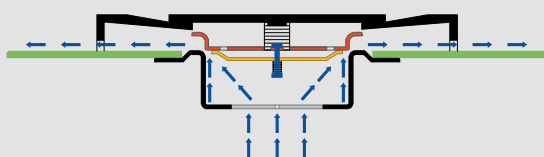

At the end of the sterilization cycle the autoclave (sterilizer) equates the pressure level and the valves opened the way by effect of vacuum.

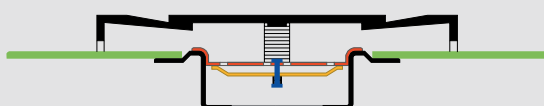

After sterilization cycle the valves of the Barrier Model Container are closed and in relax position.

BIO BARRIER

STERILIZATION CONTAINER SYSTEMS

1/1 Full Size

Box Types

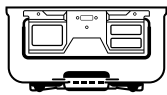

Box (With Barrier)

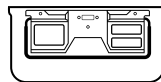

Box (Non Perforated)



Box (Non Perforated)



Code	Outside Dimension	Inside Dimension	Weight
K6-105	600 x 272 x 96 mm	543 x 258 x 90 mm	1945 g
K6-106	600 x 272 x 116 mm	543 x 258 x 110 mm	2100 g
K6-107	600 x 272 x 138 mm	543 x 258 x 132 mm	2255 g
K6-108	600 x 272 x 190 mm	543 x 258 x 184 mm	2655 g
K6-109	600 x 272 x 235 mm	543 x 258 x 229 mm	3100 g



Box (With Barrier)



Code	Outside Dimension	Inside Dimension	Weight
K7-100	600 x 272 x 108 mm	543 x 258 x 60 mm	2640 g
K7-101	600 x 272 x 128 mm	543 x 258 x 76 mm	2840 g
K7-102	600 x 272 x 150 mm	543 x 258 x 98 mm	2940 g
K7-103	600 x 272 x 197 mm	543 x 258 x 150 mm	3390 g
K7-104	600 x 272 x 247 mm	543 x 258 x 195 mm	3780 g











8 Different Colours 

Barrier System Lids

Dimension	Weight
585 x 285 mm	1840 g



Color	Code
 Grey	K7-120
 Yellow	K7-121
 Green	K7-122
 Blue	K7-123
 Red	K7-124
 Black	K7-125
 Purple	K7-126
 Bronze	K7-127

Safety Lids

Dimension	Weight
606 x 288 mm	1200 g



Color	Code
 Grey	K7-400
 Yellow	K7-401
 Green	K7-402
 Blue	K7-403
 Red	K7-404
 Black	K7-405
 Purple	K7-418
 Bronze	K7-419

BIO BARRIER

STERILIZATION CONTAINER SYSTEMS

3/4 Quarter Size

Box Types

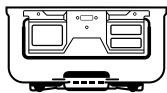

Box (With Barrier)

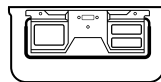

Box (Non Perforated)



Box (Non Perforated)



Code	Outside Dimension	Inside Dimension	Weight
K6-305	475 x 272 x 96 mm	422 x 258 x 90 mm	1670 g
K6-306	475 x 272 x 116 mm	422 x 258 x 110 mm	1760 g
K6-307	475 x 272 x 138 mm	422 x 258 x 132 mm	1895 g
K6-308	475 x 272 x 185 mm	422 x 258 x 179 mm	2350 g



Box (With Barrier)



Code	Outside Dimension	Inside Dimension	Weight
K7-300	475 x 272 x 108 mm	422 x 258 x 60 mm	2020 g
K7-301	475 x 272 x 128 mm	422 x 258 x 76 mm	2130 g
K7-302	475 x 272 x 150 mm	422 x 258 x 98 mm	2260 g
K7-303	475 x 272 x 197 mm	422 x 258 x 145 mm	2530 g











8 Different Colours 

Barrier System Lids

Dimension	Weight
460 x 285 mm	1250 g



Color	Code
 Grey	K7-340
 Yellow	K7-341
 Green	K7-342
 Blue	K7-343
 Red	K7-344
 Black	K7-345
 Purple	K7-346
 Bronze	K7-347

Safety Lids

Dimension	Weight
483 x 290 mm	1000 g



Color	Code
 Grey	K7-406
 Yellow	K7-407
 Green	K7-408
 Blue	K7-409
 Red	K7-410
 Black	K7-411
 Purple	K7-420
 Bronze	K7-421

BIO BARRIER

STERILIZATION CONTAINER SYSTEMS

1/2 Half Size

Box Types

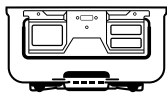

Box (With Barrier)

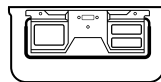

Box (Non Perforated)



Box (Non Perforated)



Code	Outside Dimension	Inside Dimension	Weight
K6-605	310 x 272 x 96 mm	253 x 258 x 90 mm	1285 g
K6-606	310 x 272 x 116 mm	253 x 258 x 110 mm	1345 g
K6-607	310 x 272 x 138 mm	253 x 258 x 132 mm	1455 g
K6-608	310 x 272 x 185 mm	253 x 258 x 184 mm	1705 g
K6-609	310 x 272 x 235 mm	253 x 258 x 229 mm	1955 g



Box (With Barrier)



Code	Outside Dimension	Inside Dimension	Weight
K7-600	310 x 272 x 108 mm	253 x 258 x 60 mm	1710 g
K7-601	310 x 272 x 128 mm	253 x 258 x 76 mm	1770 g
K7-602	310 x 272 x 150 mm	253 x 258 x 98 mm	1880 g
K7-603	310 x 272 x 197 mm	253 x 258 x 150 mm	2130 g
K7-604	310 x 272 x 247 mm	253 x 258 x 195 mm	2380 g











8 Different Colours 

Barrier System Lids

Dimension	Weight
295 x 280 mm	980 g









Color	Code
 Grey	K7-630
 Yellow	K7-631
 Green	K7-632
 Blue	K7-633
 Red	K7-634
 Black	K7-635
 Purple	K7-636
 Bronze	K7-637

Safety Lids

Dimension	Weight
317 x 285 mm	700 g



Color	Code
 Grey	K7-412
 Yellow	K7-413
 Green	K7-414
 Blue	K7-415
 Red	K7-416
 Black	K7-417
 Purple	K7-422
 Bronze	K7-423

BIO BARRIER

STERILIZATION CONTAINER SYSTEMS

Extra Large Size

Box Types

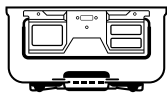

Box (With Barrier)

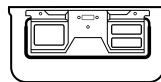

Box (Non Perforated)



Box (Non Perforated)



Code	Outside Dimension	Inside Dimension	Weight
K6-402	600 x 365 x 105 mm	543 x 350 x 99 mm	2365 g
K6-403	600 x 365 x 167 mm	543 x 350 x 161 mm	2890 g



Box (With Barrier)



Code	Outside Dimension	Inside Dimension	Weight
K7-700	600 x 365 x 117 mm	543 x 350 x 65 mm	3045 g
K7-701	600 x 365 x 179 mm	543 x 350 x 127 mm	3570 g









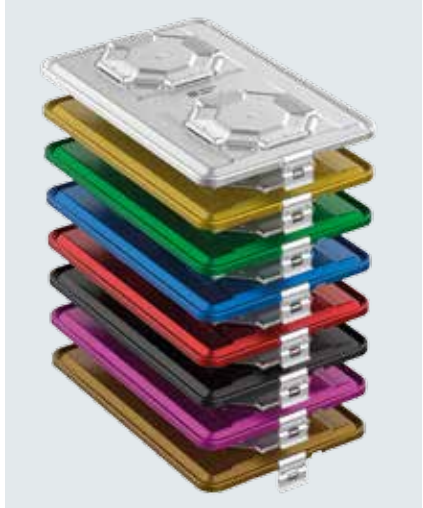

8 Different
Colours 



Barrier System Lids

Dimension	Weight
583 x 370 mm	2055 g



Color	Code
 Grey	K7-326
 Yellow	K7-327
 Green	K7-328
 Blue	K7-329
 Red	K7-330
 Black	K7-331
 Purple	K7-315
 Bronze	K7-316

BIO BARRIER

STERILIZATION CONTAINER SYSTEMS

Extra Long Size

Box Types

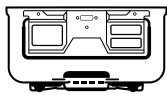

Box (With Barrier)

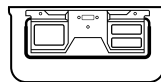

Box (Non Perforated)



Box (Non Perforated)



Code	Outside Dimension	Inside Dimension	Weight
K6-2005	725 x 275 x 127 mm	670 x 260 x 121 mm	2446 g
K6-2007	725 x 275 x 134 mm	670 x 260 x 128 mm	2503 g
K6-2006	725 x 275 x 191 mm	670 x 260 x 185 mm	2974 g



Box (With Barrier)



Code	Outside Dimension	Inside Dimension	Weight
K7-2000	725 x 275 x 138 mm	670 x 260 x 104 mm	3150 g
K7-2002	725 x 275 x 145 mm	670 x 260 x 111 mm	3282 g
K7-2001	725 x 275 x 203 mm	670 x 260 x 170 mm	3660 g











8 Different Colours 



Barrier System Lids

Dimension	Weight
710 x 285 mm	2000 g



Color	Code
 Grey	K7-2120
 Yellow	K7-2121
 Green	K7-2122
 Blue	K7-2123
 Red	K7-2124
 Black	K7-2125
 Purple	K7-2126
 Bronze	K7-2127

B³ Barrier

STERILIZATION CONTAINER SYSTEMS

PTFE  Valve  Biostop



Hermann Müller B3 model sterilization container systems are designed to provide different filtering mechanisms in a single sterilization container according to user preference. Without buying a new lid, the users are able to change the filtering system on the lid. Hermann Müller B3 model sterilization container systems can be used with 3 different filtering mechanisms.

PTFE System: This filtering mechanism is used with 2000 cycles PTFE Teflon Filter which can be changed by the user easily like in standard model filter-based sterilization containers. The filter used in this system is provided only by Hermann Müller which is placed in a cassette

Valve system: Valve system is modernized new model of Hermann Müller Bio-Barrier systems and has the same running principal. This system works with mechanic valve

with positive and negative pressure occurred during sterilization in autoclave and can be used minimum 5000 cycles.

Bio-Stop System: The Bio-Stop system is a flow inhibition system based on a principle discovered by Louis Pasteur. With a separation efficiency of 99.99 %, it offers significantly better protection against microbes and particles. This system can be used minimum 5000 cycles.

Hermann Müller B3 model sterilization container systems are manufactured as five different length, width and height. All models and sizes have specific baskets and accessories which can be viewed in following parts. Modular auto lock mechanism (thermo lock) promising sterility assurance and indicator window providing visibility of the indicator card result by visual control without opening the lid are also available for this sterilization container model.

Box Types



Box (With System)

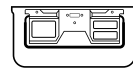

Box (Non Perforated)

Standard Heights



110 mm

135 mm

150 mm

200 mm

260 mm



Dimensions



1/2 Half Size

3/4 Quarter Size

1/1 Full Size

Extra Large Size

Extra Long Size

| Page 52 -53 |

| Page 50 -51 |

| Page 48 -49 |

| Page 54 -55 |

| Page 56 -57 |

Filtering Systems

VALVE
System



Mechanism Icon



VALVE System
Mechanism Parts



Filtering Systems

PTFE
System



Mechanism Icon



PTFE System

Mechanism Parts



Filtering Systems

BIO-STOP
System ppsu



BIO-STOP System ppsu
Mechanism Parts



Filtering Systems

BIO-STOP
System aluminium

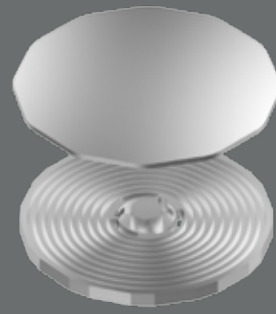

Mechanism Icon



BIO-STOP System aluminium
Mechanism Parts



B³ Barrier

STERILIZATION CONTAINER SYSTEMS

PTFE  Valve  Biostop

1/1 Full Size

Box Types

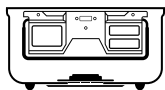

Box (With System)

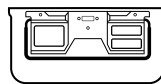

Box (Non Perforated)



Box (Non Perforated)



Code	Outside Dimension	Inside Dimension	Weight
K6-105	600 x 272 x 96 mm	543 x 258 x 90 mm	1945 g
K6-106	600 x 272 x 116 mm	543 x 258 x 110 mm	2100 g
K6-107	600 x 272 x 138 mm	543 x 258 x 132 mm	2255 g
K6-108	600 x 272 x 190 mm	543 x 258 x 184 mm	2655 g
K6-109	600 x 272 x 235 mm	543 x 258 x 229 mm	3100 g



Box (With System)



Outside Dimension : 600 x 272 Inside Dimension : 543 x 258

PTFE system



Code: K1-970
Weight: 155 g

Code
K8-100P
K8-101P
K8-102P
K8-103P
K8-104P

VALVE system



Code: K1-980
Weight: 165 g

Code
K8-100V
K8-101V
K8-102V
K8-103V
K8-104V

BIO-STOP ppsu



Code: K1-995
Weight: 237 g

Code
K8-100B
K8-101B
K8-102B
K8-103B
K8-104B

BIO-STOP aluminium



Code: K1-990A
Weight: 430 g

Code	outside	inside height
K8-100BA	110 mm	63 mm
K8-101BA	130 mm	81 mm
K8-102BA	150 mm	101 mm
K8-103BA	200 mm	153 mm
K8-104BA	250 mm	199 mm



8 Different Colours 

B3 Barrier Lids

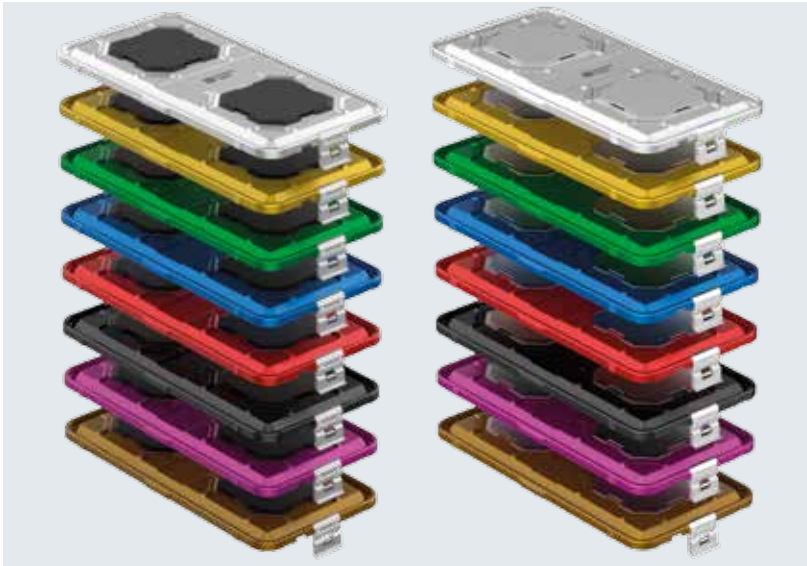

Color	PTFE system	VALVE system	BIO-STOP ppsu	BIO-STOP aluminium
Grey	K8-120P	K8-120V	K8-120B	K8-120BA
Yellow	K8-121P	K8-121V	K8-121B	K8-121BA
Green	K8-122P	K8-122V	K8-122B	K8-122BA
Blue	K8-123P	K8-123V	K8-123B	K8-123BA
Red	K8-124P	K8-124V	K8-124B	K8-124BA
Black	K8-125P	K8-125V	K8-125B	K8-125BA
Purple	K8-126P	K8-126V	K8-126B	K8-126BA
Bronze	K8-127P	K8-127V	K8-127B	K8-127BA
Weight	1570 g	1600 g	1805 g	2300 g
Dimension: 585 x 285 mm				

Safety Lids



Color	Code
Grey	K6-230
Yellow	K6-231
Green	K6-232
Blue	K6-233
Red	K6-234
Black	K6-235
Purple	K6-236
Bronze	K6-237
Weight : 1050 g	
Dimension: 606 x 288 mm	

B³ Barrier

STERILIZATION CONTAINER SYSTEMS

PTFE  Valve  Biostop

3/4 Quarter Size

Box Types

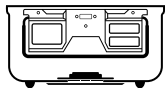

Box (With System)

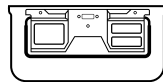

Box (Non Perforated)



Box (Non Perforated)



Code	Outside Dimension	Inside Dimension	Weight
K6-305	475 x 272 x 96 mm	422 x 258 x 90 mm	1609 g
K6-306	475 x 272 x 116 mm	422 x 258 x 110 mm	1714 g
K6-307	475 x 272 x 138 mm	422 x 258 x 132 mm	1842 g
K6-308	475 x 272 x 185 mm	422 x 258 x 179 mm	2117 g



Box (With System)



Outside Dimension : 475 x 272

Inside Dimension : 422 x 258

PTFE system



Code: K1-970
Weight: 155 g

Code
K8-300P
K8-301P
K8-302P
K8-303P

VALVE system



Code: K1-980
Weight: 165 g

Code
K8-300V
K8-301V
K8-302V
K8-303V

BIO-STOP ppsu



Code: K1-995
Weight: 237 g

Code
K8-300B
K8-301B
K8-302B
K8-303B

BIO-STOP aluminium



Code: K1-990A
Weight: 430 g

Code	outside	inside height
K8-300BA	110 mm	63 mm
K8-301BA	130 mm	81 mm
K8-302BA	150 mm	101 mm
K8-303BA	197 mm	150 mm



B3 Barrier Lids

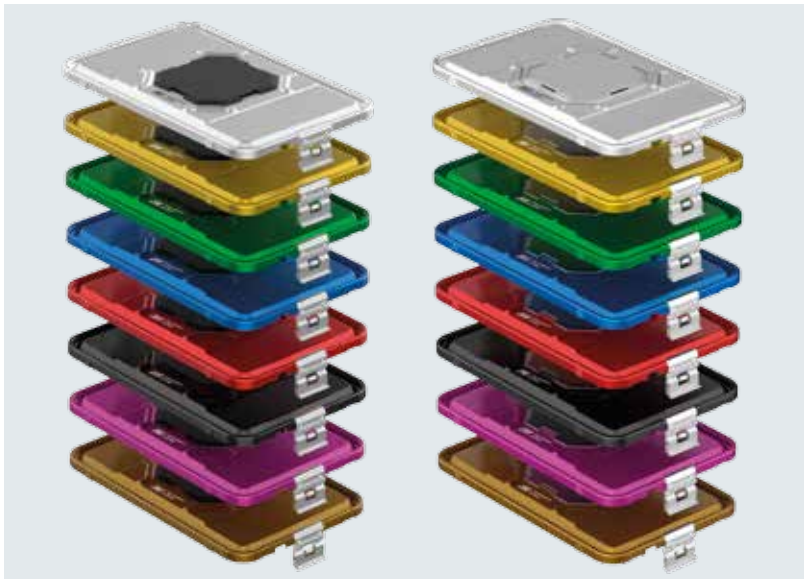

Color	PTFE system	VALVE system	BIO-STOP ppsu	BIO-STOP aluminium
Grey	K8-340P	K8-340V	K8-340B	K8-340BA
Yellow	K8-341P	K8-341V	K8-341B	K8-341BA
Green	K8-342P	K8-342V	K8-342B	K8-342BA
Blue	K8-343P	K8-343V	K8-343B	K8-343BA
Red	K8-344P	K8-344V	K8-344B	K8-344BA
Black	K8-345P	K8-345V	K8-345B	K8-345BA
Purple	K8-346P	K8-346V	K8-346B	K8-346BA
Bronze	K8-347P	K8-347V	K8-347B	K8-347BA
Weight	1030 g	1045 g	1170 g	1385 g
Dimension: 460 x 285 mm				

Safety Lids



Color	Code
Grey	K6-410
Yellow	K6-411
Green	K6-412
Blue	K6-413
Red	K6-414
Black	K6-415
Purple	K6-416
Bronze	K6-417
Weight : 900 g	
Dimension: 483 x 290 mm	

B³ Barrier

STERILIZATION CONTAINER SYSTEMS

PTFE  Valve  Biostop

1/2 Half Size

Box Types

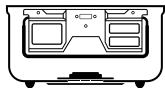

Box (With System)

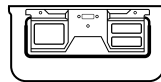

Box (Non Perforated)



Box (Non Perforated)



Code	Outside Dimension	Inside Dimension	Weight
K6-605	310 x 272 x 96 mm	253 x 258 x 90 mm	1285 g
K6-606	310 x 272 x 116 mm	253 x 258 x 110 mm	1345 g
K6-607	310 x 272 x 138 mm	253 x 258 x 132 mm	1455 g
K6-608	310 x 272 x 185 mm	253 x 258 x 179 mm	1705 g
K6-609	310 x 272 x 235 mm	253 x 258 x 229 mm	1955 g



Box (With System)



Outside Dimension : 310 x 272

Inside Dimension : 253 x 258

PTFE system



Code: K1-970
Weight: 155 g

Code
K8-600P
K8-601P
K8-602P
K8-603P
K8-604P

VALVE system



Code: K1-980
Weight: 165 g

Code
K8-600V
K8-601V
K8-602V
K8-603V
K8-604V

BIO-STOP ppsu



Code: K1-995
Weight: 237 g

Code
K8-600B
K8-601B
K8-602B
K8-603B
K8-604B

BIO-STOP aluminium



Code: K1-990A
Weight: 430 g

Code	outside / inside height
K8-600BA	110 mm 63 mm
K8-601BA	130 mm 81 mm
K8-602BA	150 mm 101 mm
K8-603BA	200 mm 153 mm
K8-604BA	250 mm 199 mm



8 Different Colours

B3 Barrier Lids

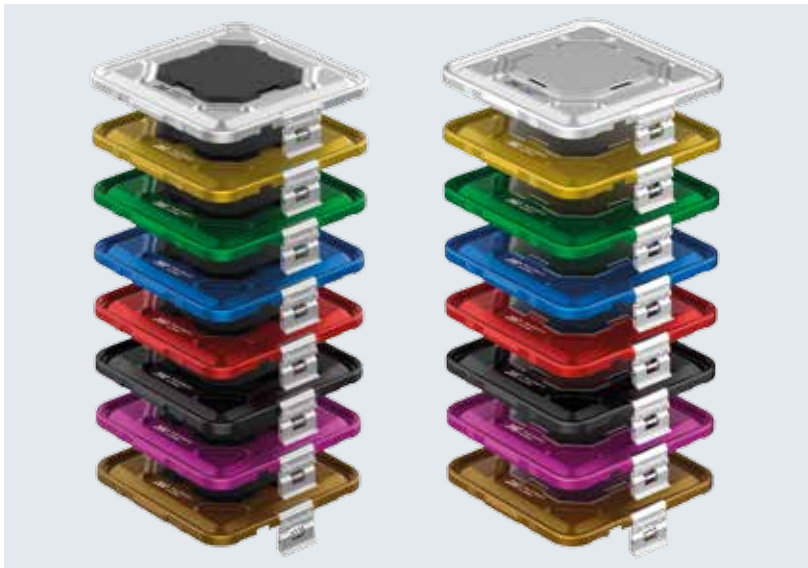

Color	PTFE system	VALVE system	BIO-STOP ppsu	BIO-STOP aluminium
Grey	K8-630P	K8-630V	K8-630B	K8-630BA
Yellow	K8-631P	K8-631V	K8-631B	K8-631BA
Green	K8-632P	K8-632V	K8-632B	K8-632BA
Blue	K8-633P	K8-633V	K8-633B	K8-633BA
Red	K8-634P	K8-634V	K8-634B	K8-634BA
Black	K8-635P	K8-635V	K8-635B	K8-635BA
Purple	K8-636P	K8-636V	K8-636B	K8-636BA
Bronze	K8-637P	K8-637V	K8-637B	K8-637BA
Weight	850 g	865 g	985 g	1200 g
Dimension: 295 x 280 mm				

Safety Lids



Color	Code
Grey	K6-700
Yellow	K6-701
Green	K6-702
Blue	K6-703
Red	K6-704
Black	K6-705
Purple	K6-706
Bronze	K6-707
Weight : 610 g	
Dimension: 317 x 285 mm	

B³ Barrier

STERILIZATION CONTAINER SYSTEMS

PTFE  Valve  Biostop

Extra Large Size

Box Types

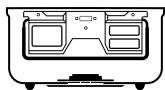

Box (With System)

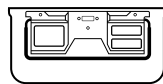

Box (Non Perforated)



Box (Non Perforated)



Code	Outside Dimension	Inside Dimension	Weight
K6-402	600 x 365 x 105 mm	543 x 350 x 99 mm	2271 g
K6-403	600 x 365 x 167 mm	543 x 350 x 161 mm	2856 g



Box (With System)



Outside Dimension : 600 x 365 Inside Dimension : 543 x 350

PTFE system

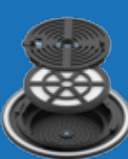

Code: K1-970
Weight: 155 g

Code
K8-700P
K8-701P

VALVE system



Code: K1-980
Weight: 165 g

Code
K8-700V
K8-701V

BIO-STOP ppsu



Code: K1-995
Weight: 237 g

Code
K8-700B
K8-701B

BIO-STOP aluminium



Code: K1-990A
Weight: 430 g







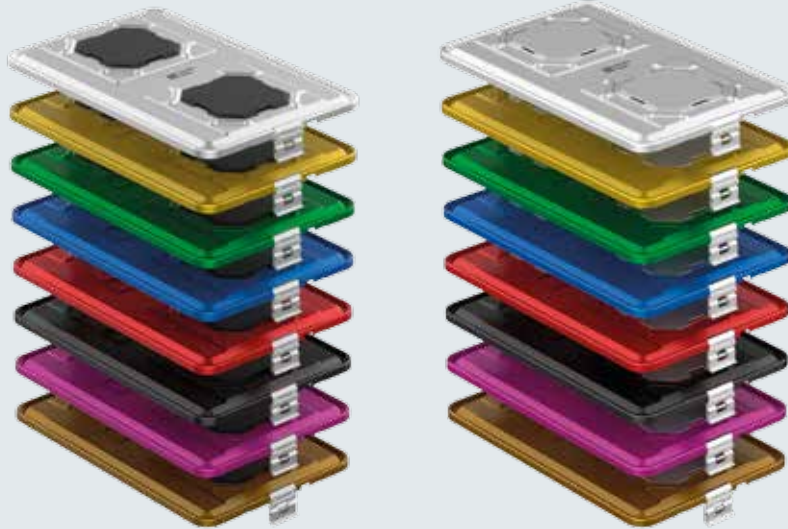

Code	outside	inside height
K8-700BA	120 mm	69 mm
K8-701BA	180 mm	131 mm



8 Different
Colours 

B3 Barrier Lids



Color	PTFE system	VALVE system	BIO-STOP ppsu	BIO-STOP aluminium
 Grey	K8-326P	K8-326V	K8-326B	K8-326BA
 Yellow	K8-327P	K8-327V	K8-327B	K8-327BA
 Green	K8-328P	K8-328V	K8-328B	K8-328BA
 Blue	K8-329P	K8-329V	K8-329B	K8-329BA
 Red	K8-330P	K8-330V	K8-330B	K8-330BA
 Black	K8-331P	K8-331V	K8-331B	K8-331BA
 Purple	K8-315P	K8-315V	K8-315B	K8-315BA
 Bronze	K8-316P	K8-316V	K8-316B	K8-316BA
Weight	1830 g	1854 g	2090 g	2347 g
Dimension: 583 x 370 mm				

B³ Barrier

STERILIZATION CONTAINER SYSTEMS

PTFE  Valve  Biostop

Extra Long Size

Box Types

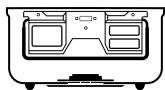

Box (With System)

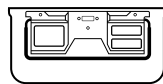

Box (Non Perforated)



Box (Non Perforated)



Code	Outside Dimension	Inside Dimension	Weight
K6-2005	725 x 275 x 127 mm	670 x 260 x 121 mm	2446 g
K6-2007	725 x 275 x 134 mm	670 x 260 x 128 mm	2503 g
K6-2006	725 x 275 x 191 mm	670 x 260 x 185 mm	2974 g



Box (With System)









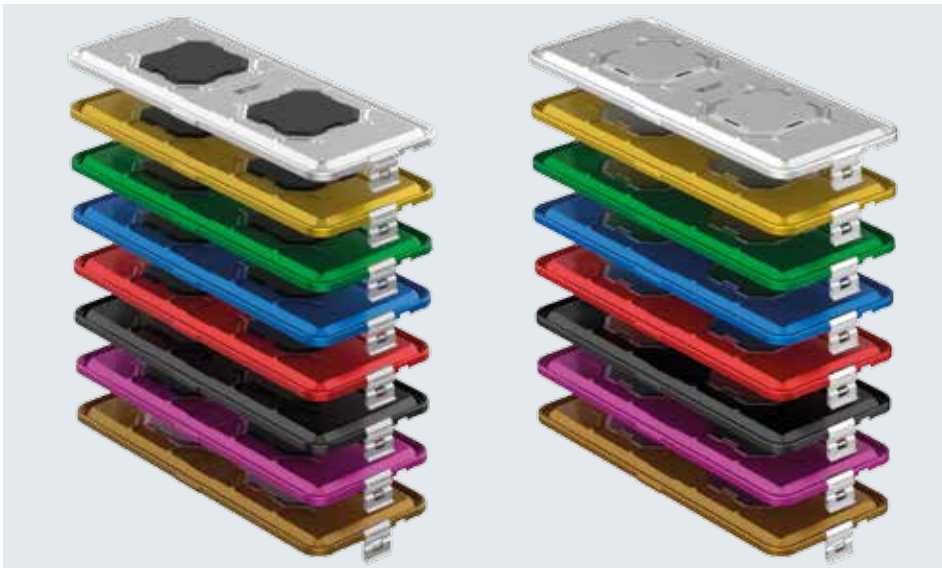

Outside Dimension : 725 x 275 Inside Dimension : 670 x 260

PTFE system	Code	VALVE system	Code	BIO-STOP ppsu	Code	BIO-STOP aluminium	Code	outside / inside height
	K8-2000P		K8-2000V		K8-2000B		K8-2000BA	138 mm / 95 mm
	K8-2001P		K8-2001V		K8-2001B		K8-2002BA	145 mm / 102 mm
	K8-2002P		K8-2002V		K8-2002B		K8-2001BA	203 mm / 163 mm
Code: K1-970 Weight: 155 g		Code: K1-980 Weight: 165 g		Code: K1-995 Weight: 237 g		Code: K1-990A Weight: 430 g		



B3 Barrier Lids



Color	PTFE system	VALVE system	BIO-STOP ppsu	BIO-STOP aluminium
 Grey	K8-2120P	K8-2120V	K8-2120B	K8-2120BA
 Yellow	K8-2121P	K8-2121V	K8-2121B	K8-2121BA
 Green	K8-2122P	K8-2122V	K8-2122B	K8-2122BA
 Blue	K8-2123P	K8-2123V	K8-2123B	K8-2123BA
 Red	K8-2124P	K8-2124V	K8-2124B	K8-2124BA
 Black	K8-2125P	K8-2125V	K8-2125B	K8-2125BA
 Purple	K8-2126P	K8-2126V	K8-2126B	K8-2126BA
 Bronze	K8-2127P	K8-2127V	K8-2127B	K8-2127BA
Weight	1386 g	1810 g	2047 g	2303 g
Dimension: 710 x 285 mm				

WINDOW MODEL

STERILIZATION CONTAINER SYSTEMS

Hermann Müller window model sterilization container system is one of its patented products. What makes this model different from the others is the window on the lid which its name comes from. This window is made of high performance PPSU transparent material which is resistant against high temperature, impacts, scratches, deformation, discoloration and chemicals and it opens users a way to visually check inside of the sterilization container without opening the lid. The window model lids assure great tightness due to its special assembly method and the gasket system in it. As there is no filtering mechanism on the lid, window model sterilization container boxes strictly must be bottom perforated. Either single use paper or 2000 cycles PTFE Teflon Filters can be used in the box. In order to allow the air flow and reach

to perfect steam penetration the filtering mechanism of this model must have enough space. For that purpose, this sterilization container model is supplied with a wire base inside the container as standard. Except for this container model, all Hermann Müller boxes and lids are compatible with each other.

Hermann Müller window model sterilization container systems are manufactured as five different length, width and height. All models and sizes have specific baskets and accessories which can be viewed in following parts. Modular auto lock mechanism (thermo lock) promising sterility assurance and indicator window providing visibility of the indicator card result by visual control without opening the lid are also available for this sterilization container model.

Box Types



Box (With Wire Base)

8 Different Colours



Standard Heights



111 mm

131 mm

153 mm

205 mm

260 mm



Dimensions



1/1 Full Size

| Page 60 -61 |

3/4 Quarter Size

| Page 62 -63 |

1/2 Half Size

| Page 64 -65 |

WINDOW MODEL

STERILIZATION CONTAINER SYSTEMS

1/1 Full Size

Box Types

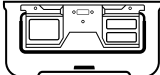

Box (With Wire Base)





8 Different Colours



 **Box (With Wire Base)**



Code	Outside Dimension	Inside Dimension	Weight
K6-100D	600 x 272 x 111 mm	543 x 258 x 66 mm	2935 g
K6-101D	600 x 272 x 131 mm	543 x 258 x 82 mm	3095 g
K6-102D	600 x 272 x 153 mm	543 x 258 x 104 mm	3255 g
K6-103D	600 x 272 x 197 mm	543 x 258 x 156 mm	3710 g
K6-104D	600 x 272 x 250 mm	543 x 258 x 201 mm	4090 g

Window Lids



Color	Code	Color	Code
 Grey	K6-120D	 Red	K6-124D
 Yellow	K6-121D	 Black	K6-125D
 Green	K6-122D	 Purple	K6-126D
 Blue	K6-123D	 Bronze	K6-127D
Dimension	602 x 285 mm	Weight	1305 g

WINDOW MODEL

STERILIZATION CONTAINER SYSTEMS

3/4 Quarter Size

Box Types



Box (With Wire Base)





8 Different Colours 









 **Box (With Wire Base)**



Code	Outside Dimension	Inside Dimension	Weight
K6-300D	475 x 272 x 111 mm	422 x 258 x 66 mm	2360 g
K6-301D	475 x 272 x 131 mm	422 x 258 x 82 mm	2450 g
K6-302D	475 x 272 x 153 mm	422 x 258 x 104 mm	2585 g
K6-303D	475 x 272 x 200 mm	422 x 258 x 151 mm	3040 g

Window Lids



Color	Code	Color	Code
 Grey	K6-340D	 Red	K6-344D
 Yellow	K6-341D	 Black	K6-345D
 Green	K6-342D	 Purple	K6-346D
 Blue	K6-343D	 Bronze	K6-347D

Dimension 477 x 285 mm **Weight** 1020 g

WINDOW MODEL

STERILIZATION CONTAINER SYSTEMS

1/2 Half Size

Box Types

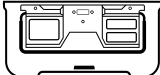

Box (With Wire Base)





8 Different Colours



 **Box (With Wire Base)**



Code	Outside Dimension	Inside Dimension	Weight
K6-600D	310 x 272 x 111 mm	253 x 258 x 66 mm	1765 g
K6-601D	310 x 272 x 131 mm	253 x 258 x 82 mm	1825 g
K6-602D	310 x 272 x 153 mm	253 x 258 x 104 mm	1935 g
K6-603D	310 x 272 x 197 mm	253 x 258 x 156 mm	2185 g
K6-604D	310 x 272 x 250 mm	253 x 258 x 201 mm	2435 g

Window Lids



Color	Code	Color	Code
Grey	K6-630D	Red	K6-634D
Yellow	K6-631D	Black	K6-635D
Green	K6-632D	Purple	K6-636D
Blue	K6-633D	Bronze	K6-637D
Dimension	312 x 280 mm	Weight	736 g

PLASMA MODEL

LOW TEMPERATURE STERILIZATION CONTAINER SYSTEMS

Hermann Müller plasma model container systems are designed for both steam and plasma sterilization (destroying the microorganisms by free radicals). The suitable accessories like paper filter for steam or polypropylene filter for plasma must be chosen by the user according to the need. The plasma model containers are equipped with carrying handles which have 90° mobility and its ergonomic design provides easy and secure carrying facilities. The gaskets inside the lid and filter retainer ensure perfect tightness while locking mechanism of this system provides excellent grip with its flexible structure.

Hermann Müller plasma model sterilization container systems are manufactured with different length, width and height and can be supplied with perforated bottom and lids. All models and sizes have specific baskets and accessories which can be viewed in following parts.

Box Types

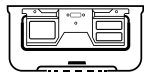

Box (Perforated)

Standard Heights & Dimensions



110 mm



135 mm

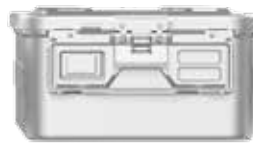

150 mm



200 mm



1/1 Full Size



3/4 Quarter Size



1/2 Half Size



Page 68 - 69



Special Models



ENDO MODEL

MINI MODEL

DENTAL MODEL

1/2 DENTAL MODEL

Page 72 - 73

Page 70 - 71

PLASMA MODEL

LOW TEMPERATURE
STERILIZATION CONTAINER SYSTEMS

1/1 Full Size

3/4 Quarter Size

1/2 Half Size

Box Types



Box (Perforated)





Box (Perforated)

Perforated Lid

1/1 FULL SIZE

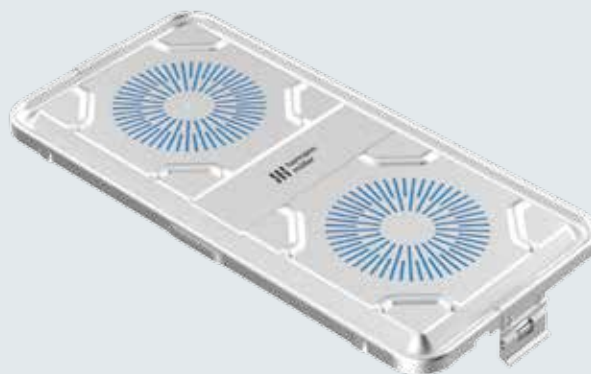

Code	Outside Dimension	Inside Dimension	Weight
K6-100Z	600 x 272 x 96 mm	543 x 258 x 90 mm	2200 g
K6-101Z	600 x 272 x 116 mm	543 x 258 x 99 mm	2360 g
K6-102Z	600 x 272 x 138 mm	543 x 258 x 121 mm	2520 g

Color	Code
Grey	K6-120Z
Dimension	Weight
585 x 285 mm	1370 g

3/4 QUARTER

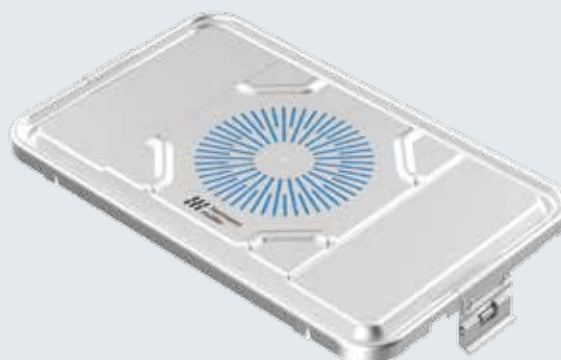

Code	Outside Dimension	Inside Dimension	Weight
K6-300Z	475 x 272 x 96 mm	422 x 258 x 78 mm	1795 g
K6-301Z	475 x 272 x 116 mm	422 x 258 x 99 mm	1885 g
K6-302Z	475 x 272 x 138 mm	422 x 258 x 121 mm	2020 g
K6-303Z	475 x 272 x 185 mm	422 x 258 x 168 mm	2475 g

Color	Code
Grey	K6-340Z
Dimension	Weight
460 x 285 mm	1020 g

1/2 HALF SIZE

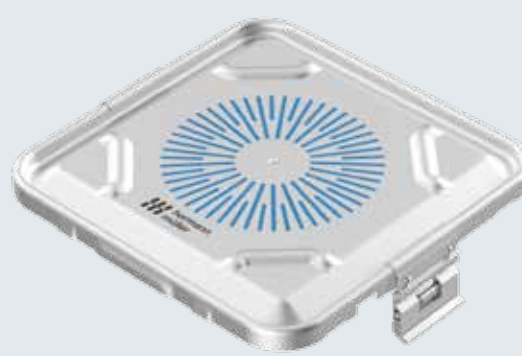

Code	Outside Dimension	Inside Dimension	Weight
K6-600Z	310 x 272 x 96 mm	253 x 258 x 78 mm	1400 g
K6-601Z	310 x 272 x 116 mm	253 x 258 x 99 mm	1460 g
K6-602Z	310 x 272 x 138 mm	253 x 258 x 121 mm	1570 g

Color	Code
Grey	K6-630Z
Dimension	Weight
295 x 280 mm	765 g

PLASMA MODEL

LOW TEMPERATURE
STERILIZATION CONTAINER SYSTEMS

Mini Model

Dental Model

1/2 Dental Model

Box Types

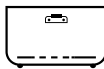
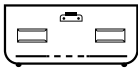
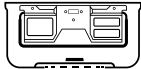

Box (*Perforated*)





Box (Perforated)

Perforated Lid

DENTAL MODEL

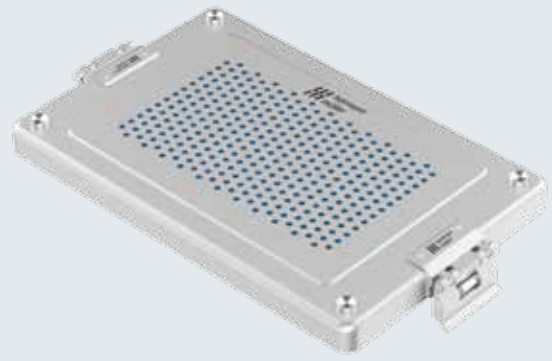

Code	Outside Dimension	Weight
K6-1860Z	323 x 186 x 43 mm	493 g
K6-1861Z	323 x 186 x 58 mm	535 g
K6-1862Z	323 x 186 x 122 mm	745 g

Color	Code
Grey	K6-1880Z
Dimension	Weight
325 x 192 mm	638 g

1/2 DENTAL MODEL

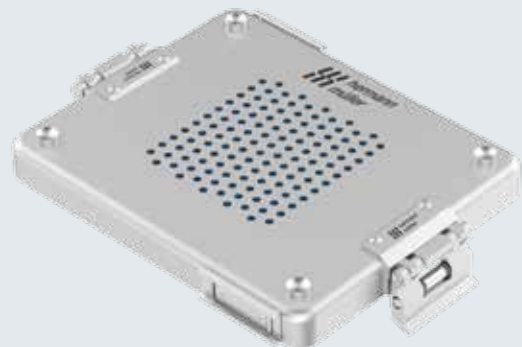

Code	Outside Dimension	Weight
K6-1560Z	227 x 162 x 57 mm	386 g
K6-1561Z	227 x 162 x 88 mm	463 g
K6-1562Z	227 x 162 x 122 mm	525 g

Color	Code
Grey	K6-1570Z
Dimension	Weight
220 x 170 mm	488 g

MINI MODEL

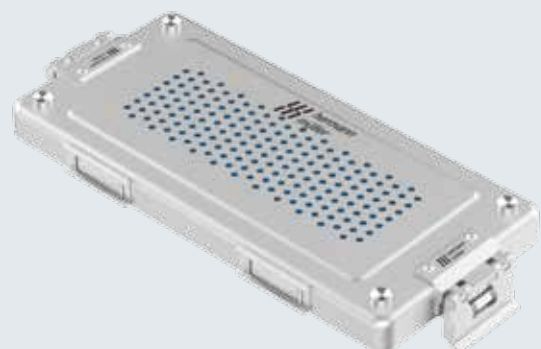

Code	Outside Dimension	Weight
K6-1960Z	315 x 132 x 32 mm	338 g
K6-1961Z	315 x 132 x 63 mm	432 g
K6-1962Z	315 x 132 x 92 mm	523 g

Color	Code
Grey	K6-1970Z
Dimension	Weight
320 x 142 mm	513 g

PLASMA MODEL

LOW TEMPERATURE
STERILIZATION CONTAINER SYSTEMS

Endo Model

Box Types

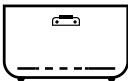

Box (Perforated)





Box (Perforated)

Perforated Lid

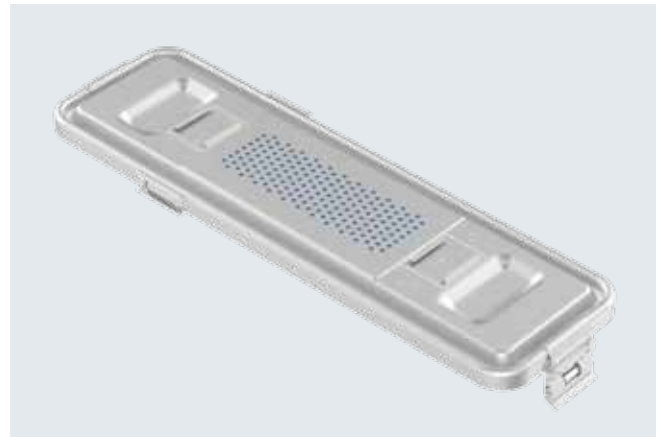

Code	Outside Dimension	Weight
K6-1100Z	528 x 145 x 66 mm	676 g
K6-1101Z	528 x 145 x 88 mm	786 g

Color	Code
Grey	K6-1000Z
Dimension	Weight
532 x 160 mm	795 g

DENTAL, MINI & SPECIAL MODELS

STERILIZATION CONTAINER SYSTEMS

As an addition to all standard sizes, Hermann Müller also provides smaller containers like Mini, Large Dental, Dental, ½ Dental, Flat, Endo, Implant, Scopy and Mini Implant Model for preparation of many surgeries like dental or micro surgeries.

Box Types

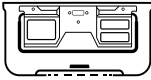

Box (Perforated)

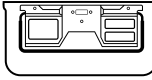

Box (Non Perforated)



Models



LARGE DENTAL MODEL ▶ Page 76 -77



DENTAL MODEL ▶ Page 78 -79



1/2 DENTAL MODEL ▶ Page 80 -81



ENDO MODEL ▶ Page 82 -83



MINI MODEL ▶ Page 84 -85

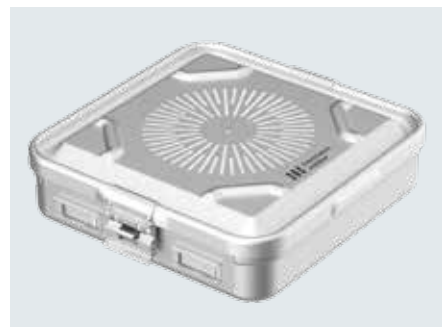

FLAT MODEL ▶ Page 86 -87



IMPLANT MODEL ▶ Page 88

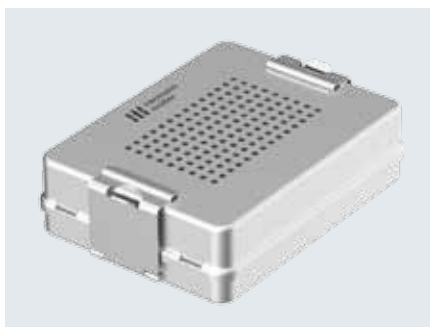

MINI IMPLANT MODEL ▶ Page 89

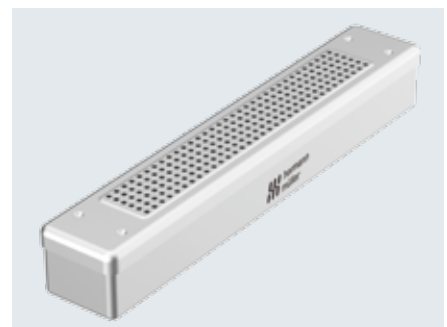

SCOPY MODEL ▶ Page 91 -91

LARGE DENTAL

STERILIZATION CONTAINER SYSTEMS

Box Types

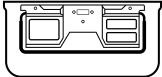

Box (Non Perforated)

Standard Heights



115 mm

130 mm

150 mm

Box (Non Perforated)



Code	Outside Dimension	Inside Dimension	Weight
K6-1665	380 x 244 x 100 mm	330 x 234 x 94 mm	1350 g
K6-1666	380 x 244 x 116 mm	330 x 234 x 112 mm	1465 g
K6-1667	380 x 244 x 138 mm	330 x 234 x 130 mm	1600 g



8 **Different Colours**

Perforated Lids

Dimension	Weight
365 x 255 mm	835 g



Color	Code
Grey	K6-1680
Yellow	K6-1681
Green	K6-1682
Blue	K6-1683
Red	K6-1684
Black	K6-1685
Purple	K6-1686
Bronze	K6-1687

Removal Lids

Dimension	Weight
365 x 255 mm	765 g



Color	Code
Grey	K6-1690
Yellow	K6-1691
Green	K6-1692
Blue	K6-1693
Red	K6-1694
Black	K6-1695
Purple	K6-1696
Bronze	K6-1697

Bio Barrier Lids

Dimension	Weight
365 x 255 mm	1020 g



Color	Code
Grey	K7-1680
Yellow	K7-1681
Green	K7-1682
Blue	K7-1683
Red	K7-1684
Black	K7-1685
Purple	K7-1686
Bronze	K7-1687

DENTAL MODEL

STERILIZATION CONTAINER SYSTEMS

Box Types

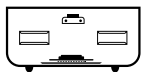

Box (With Barrier)

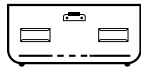

Box (Perforated)

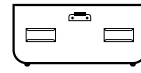

Box (Non Perforated)

Standard Heights



55 mm



70 mm



100 mm



135 mm



Box (Non Perforated)



Code	Outside Dimension	Inside Dimension	Weight
K6-1865	320 x 186 x 43 mm	281 x 184 x 38 mm	360 g
K6-1866	320 x 186 x 59 mm	281 x 184 x 54 mm	425 g
K6-1868	320 x 186 x 102 mm	281 x 184 x 98 mm	560 g
K6-1867	320 x 186 x 122 mm	281 x 184 x 118 mm	634 g



Box (Perforated)



Code	Outside Dimension	Inside Dimension	Weight
K6-1860	320 x 186 x 43 mm	281 x 184 x 28 mm	500 g
K6-1861	320 x 186 x 58 mm	281 x 184 x 46 mm	550 g
K6-1863	320 x 186 x 102 mm	281 x 184 x 93 mm	695 g
K6-1862	320 x 186 x 122 mm	281 x 184 x 110 mm	755 g



Box (With Barrier)



Code	Outside Dimension	Inside Dimension	Weight
K7-1861	320 x 186 x 69 mm	281 x 184 x 35 mm	765 g
K7-1863	320 x 186 x 112 mm	281 x 184 x 79 mm	910 g
K7-1862	320 x 186 x 132 mm	281 x 184 x 99 mm	984 g



8 Different Colours 

Perforated Lids

Dimension	Weight
325 x 192 mm	638 g



Color	Code
Grey	K6-1880
Yellow	K6-1881
Green	K6-1882
Blue	K6-1883
Red	K6-1884
Black	K6-1885
Purple	K6-1886
Bronze	K6-1887

Removal Lids

Dimension	Weight
325 x 192 mm	500 g



Color	Code
Grey	K6-1870
Yellow	K6-1871
Green	K6-1872
Blue	K6-1873
Red	K6-1874
Black	K6-1875
Purple	K6-1876
Bronze	K6-1877

Barrier Lids

Dimension	Weight
325 x 192 mm	862 g



Color	Code
Grey	K7-1880
Yellow	K7-1881
Green	K7-1882
Blue	K7-1883
Red	K7-1884
Black	K7-1885
Purple	K7-1886
Bronze	K7-1887

1/2 DENTAL MODEL

STERILIZATION CONTAINER SYSTEMS

Box Types

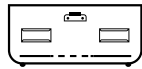

Box (Perforated)

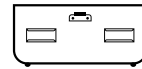

Box (Non Perforated)

Standard Height Dimensions



63 mm



100 mm



130 mm



Box (Non Perforated)



Code	Outside Dimension	Inside Dimension	Weight
K6-1565	227 x 162 x 57 mm	190 x 158 x 48 mm	245 g
K6-1566	227 x 162 x 88 mm	190 x 158 x 88 mm	335 g
K6-1567	227 x 162 x 122 mm	190 x 158 x 118 mm	410 g



Box (Perforated)



Code	Outside Dimension	Inside Dimension	Weight
K6-1560	227 x 162 x 57 mm	190 x 158 x 40 mm	385 g
K6-1561	227 x 162 x 88 mm	190 x 158 x 80 mm	440 g
K6-1562	227 x 162 x 122 mm	190 x 158 x 110 mm	545 g











8 Different Colours 

Perforated Lids

Dimension	Weight
232 x 174 mm	495 g









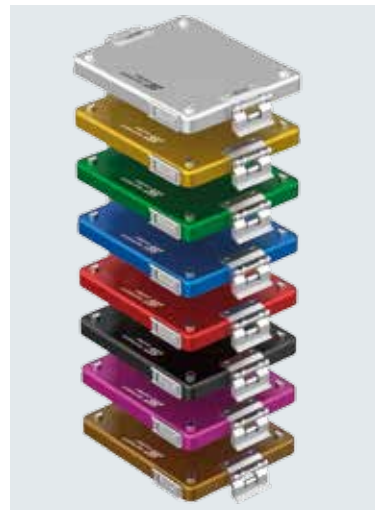

Color	Code
 Grey	K6-1570
 Yellow	K6-1571
 Green	K6-1572
 Blue	K6-1573
 Red	K6-1574
 Black	K6-1575
 Purple	K6-1576
 Bronze	K6-1577

Removal Lids

Dimension	Weight
232 x 174 mm	360 g



Color	Code
 Grey	K6-1580
 Yellow	K6-1581
 Green	K6-1582
 Blue	K6-1583
 Red	K6-1584
 Black	K6-1585
 Purple	K6-1586
 Bronze	K6-1587

ENDO MODEL

STERILIZATION CONTAINER SYSTEMS

Box Types



Box (Perforated)

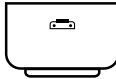

Box (Non Perforated)



Code	Outside Dimension	Weight
K6-1105	528 x 145 x 66 mm	675 g
K6-1106	528 x 145 x 88 mm	805 g



Code	Outside Dimension	Weight
K6-1100	528 x 145 x 66 mm	690 g
K6-1101	528 x 145 x 88 mm	885 g



8 Different
Colours 





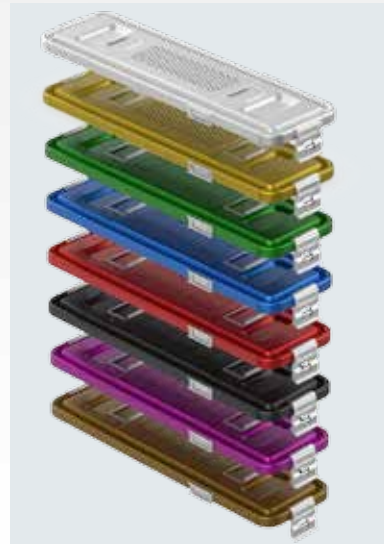

Perforated Lids

Dimension
532 x 160 mm

Weight
775 g



Color	Code
 Grey	K6-1000
 Yellow	K6-1001
 Green	K6-1002
 Blue	K6-1003
 Red	K6-1004
 Black	K6-1005
 Purple	K6-1006
 Bronze	K6-1007

MINI MODEL

STERILIZATION CONTAINER SYSTEMS

Box Types



Box (With Barrier)

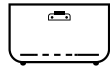

Box (Perforated)

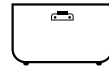

Box (Non Perforated)

Standard Heights



45 mm



70 mm



100 mm

2 dimension Bio Barrier Options

Box (Non Perforated)



Code	Outside Dimension	Inside Dimension	Weight
K6-1965	315 x 132 x 32 mm	273 x 128 x 30 mm	232 g
K6-1966	315 x 132 x 63 mm	273 x 128 x 58 mm	315 g
K6-1967	315 x 132 x 92 mm	273 x 128 x 90 mm	419 g

Box (Perforated)



Code	Outside Dimension	Inside Dimension	Weight
K6-1960	315 x 132 x 32 mm	273 x 128 x 18 mm	350 g
K6-1961	315 x 132 x 63 mm	273 x 128 x 48 mm	440 g
K6-1962	315 x 132 x 92 mm	273 x 128 x 78 mm	523 g

Box (With Barrier)



Code	Outside Dimension	Inside Dimension	Weight
K7-1961	315 x 132 x 73 mm	273 x 128 x 39 mm	665 g
K7-1962	315 x 132 x 102 mm	273 x 128 x 71 mm	769 g



8 Different Colours 

Perforated Lids

Dimension	Weight
315 x 140 mm	510 g



Color	Code
Grey	K6-1970
Yellow	K6-1971
Green	K6-1972
Blue	K6-1973
Red	K6-1974
Black	K6-1975
Purple	K6-1976
Bronze	K6-1977

Removal Lids

Dimension	Weight
315 x 140 mm	380 g



Color	Code
Grey	K6-1980
Yellow	K6-1981
Green	K6-1982
Blue	K6-1983
Red	K6-1984
Black	K6-1985
Purple	K6-1986
Bronze	K6-1987

Barrier Lids

Dimension	Weight
315 x 142 mm	680 g



Color	Code
Grey	K7-1970
Yellow	K7-1971
Green	K7-1972
Blue	K7-1973
Red	K7-1974
Black	K7-1975
Purple	K7-1976
Bronze	K7-1977

FLAT MODEL

STERILIZATION CONTAINER SYSTEMS

Box Types

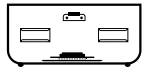

Box (With Barrier)

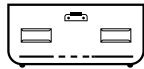

Box (Perforated)

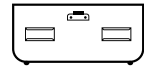

Box (Non Perforated)

Standard Heights



75 mm







90 mm

2 dimension Bio Barrier Options

 Box (Non Perforated)		Code Outside Dimension Inside Dimension Weight
		K6-1775 295 x 270 x 60 mm 258 x 260 x 56 mm 650 g
		K6-1776 295 x 270 x 72 mm 258 x 260 x 66 mm 720 g
 Box (Perforated)		Code Outside Dimension Inside Dimension Weight
		K6-1770 295 x 270 x 60 mm 258 x 260 x 40 mm 740 g
		K6-1771 295 x 270 x 72 mm 258 x 260 x 52 mm 825 g
 Box (With Barrier)		Code Outside Dimension Inside Dimension Weight
		K7-1770 295 x 270 x 72 mm 258 x 260 x 37 mm 964 g
		K7-1771 295 x 270 x 84 mm 258 x 260 x 47 mm 987 g



8 **Different**
Colours 

Perforated Lids		Removal Lids		Bio Barrier Lids		Safety Lids		For Bio Barrier Safety Lids	
Dimension	Weight	Dimension	Weight	Dimension	Weight	Dimension	Weight	Dimension	Weight
295 x 280 mm	730 g	295 x 280 mm	610 g	295 x 280 mm	955 g	317 x 285 mm	610 g	317 x 285 mm	700 g
									
Color	Code	Color	Code	Color	Code	Color	Code	Color	Code
Grey	K6-1780	Grey	K6-1790	Grey	K7-1780	Grey	K6-1418	Grey	K7-1418
Yellow	K6-1781	Yellow	K6-1791	Yellow	K7-1781	Yellow	K6-1419	Yellow	K7-1419
Green	K6-1782	Green	K6-1792	Green	K7-1782	Green	K6-1420	Green	K7-1420
Blue	K6-1783	Blue	K6-1793	Blue	K7-1783	Blue	K6-1421	Blue	K7-1421
Red	K6-1784	Red	K6-1794	Red	K7-1784	Red	K6-1422	Red	K7-1422
Black	K6-1785	Black	K6-1795	Black	K7-1785	Black	K6-1423	Black	K7-1423
Purple	K6-1786	Purple	K6-1796	Purple	K7-1786	Purple	K6-1424	Purple	K7-1424
Bronze	K6-1787	Bronze	K6-1797	Bronze	K7-1787	Bronze	K6-1425	Bronze	K7-1425

IMPLANT MODEL

STERILIZATION CONTAINER SYSTEMS

Box & Lids Types

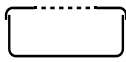

Lid Perforated
Box Non Perforated



Lid Perforated
Box Perforated

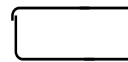

Lid Non Perforated
Box Non Perforated

All container measurements cover the outer size of the lids.

Dimension	Implant Models	Lid Perforated Box Non Perforated	Lid Perforated Box Perforated	Lid Non Perforated Box Non Perforated	
300 x 150 x 75 mm		Color	Code	Code	Code
		Black	K5-010	K5-022	K5-034
		Red	K5-011	K5-023	K5-035
		Blue	K5-012	K5-024	K5-036
		Green	K5-013	K5-025	K5-037
		Yellow	K5-014	K5-026	K5-038
		Grey	K5-015	K5-027	K5-039
		Purple	K5-048	K5-052	K5-056
		Bronze	K5-049	K5-053	K5-057
		500 x 170 x 75 mm		Color	Code
Black	K5-016			K5-028	K5-040
Red	K5-017			K5-029	K5-041
Blue	K5-018			K5-030	K5-042
Green	K5-019			K5-031	K5-043
Yellow	K5-020			K5-032	K5-044
Grey	K5-021			K5-033	K5-045
Purple	K5-050			K5-054	K5-058
Bronze	K5-051			K5-055	K5-059

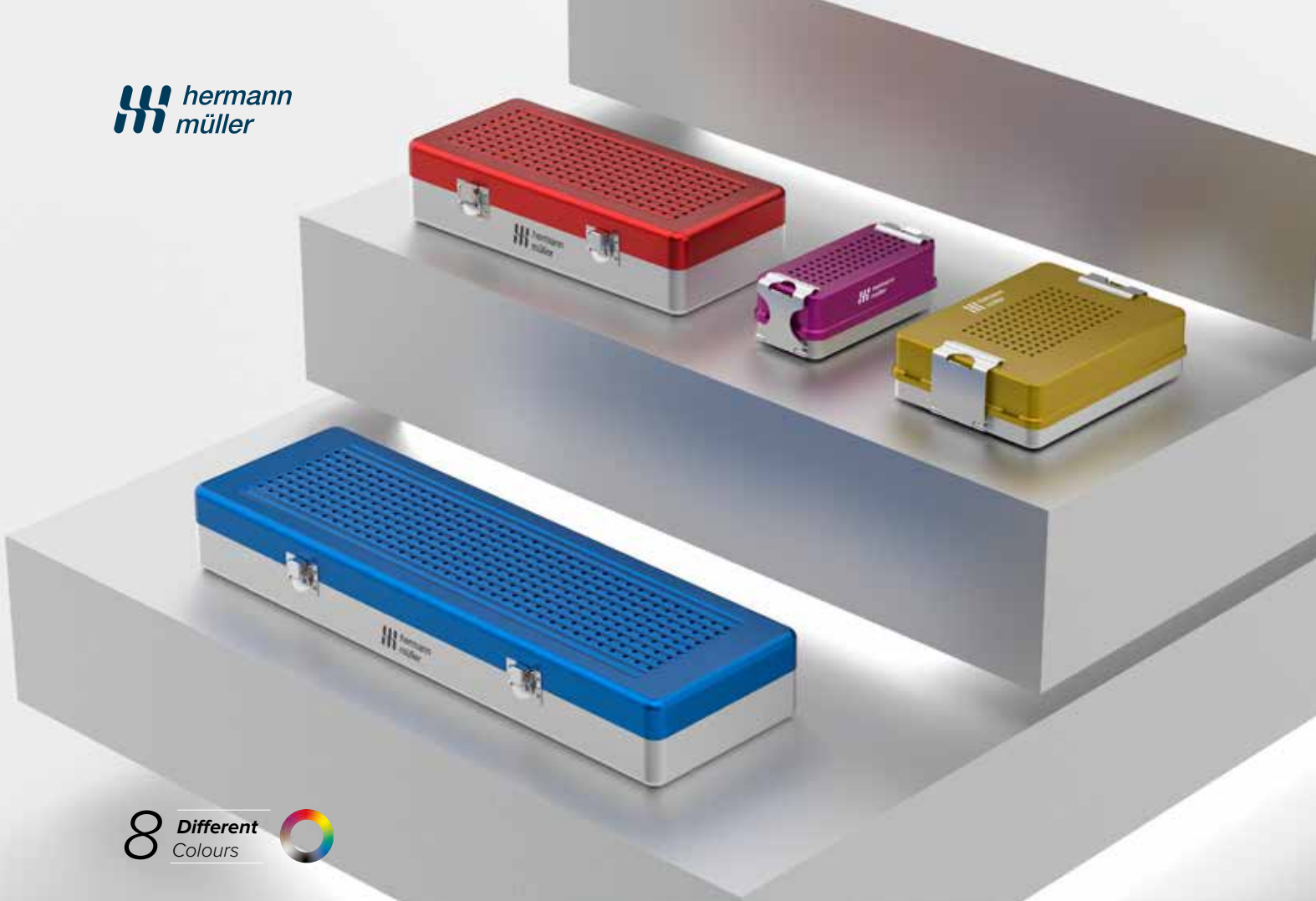









8 **Different Colours** 







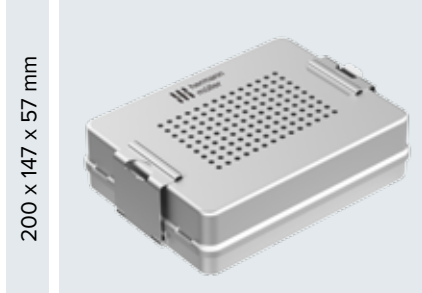

Dimension Lid Perforated Box Non Perforated Lid Perforated Box Perforated Lid Non Perforated Box Non Perforated

Mini Implant Models



Color	Code	Code	Code
 Black	K5-200	K5-212	K5-224
 Red	K5-201	K5-213	K5-225
 Blue	K5-202	K5-214	K5-226
 Green	K5-203	K5-215	K5-227
 Yellow	K5-204	K5-216	K5-228
 Grey	K5-205	K5-217	K5-229
 Purple	K5-236	K5-240	K5-244
 Bronze	K5-237	K5-241	K5-245



Color	Code	Code	Code
 Black	K5-206	K5-218	K5-230
 Red	K5-207	K5-219	K5-231
 Blue	K5-208	K5-220	K5-232
 Green	K5-209	K5-221	K5-233
 Yellow	K5-210	K5-222	K5-234
 Grey	K5-211	K5-223	K5-235
 Purple	K5-238	K5-242	K5-246
 Bronze	K5-239	K5-243	K5-247

SCOPY MODEL

STERILIZATION CONTAINER SYSTEMS

Box & Lids Types

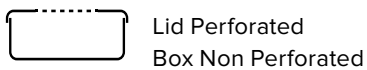

Lid Perforated
Box Non Perforated





Lid Perforated
Box Perforated

All container measurements cover the outer size of the lids.

Dimension	Scopy Models	Lid Perforated Box Non Perforated	Lid Perforated Box Perforated	
260 x 70 x 60 mm		Color	Code	Code
		Black	K5-060	K5-072
		Red	K5-061	K5-073
		Blue	K5-062	K5-074
		Green	K5-063	K5-075
		Yellow	K5-064	K5-076
		Grey	K5-065	K5-077
		Purple	K5-084	K5-088
		Bronze	K5-085	K5-089
		455 x 80 x 70 mm		Color
Black	K5-066			K5-078
Red	K5-067			K5-079
Blue	K5-068			K5-080
Green	K5-069			K5-081
Yellow	K5-070			K5-082
Grey	K5-071			K5-083
Purple	K5-086			K5-090
Bronze	K5-087			K5-091

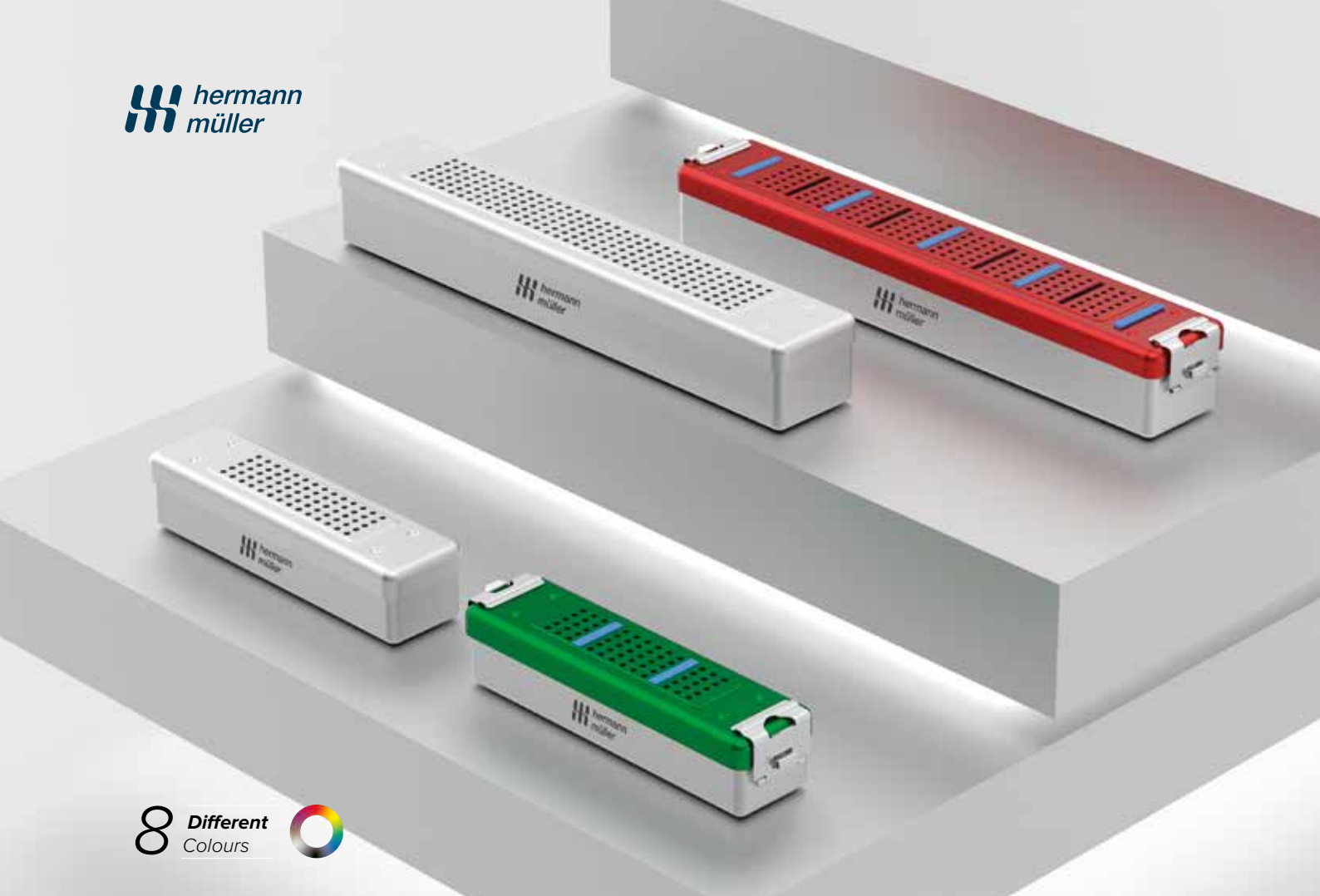



8 Different Colours 

Dimension

Scopy Models

with silicone holders

Lid Perforated
Box Non Perforated











Lid Perforated
Box Perforated



275 x 70 x 65 mm











Color	Code	Code
 Black	K5-100	K5-115
 Red	K5-101	K5-116
 Blue	K5-102	K5-117
 Green	K5-103	K5-118
 Yellow	K5-104	K5-119
 Grey	K5-105	K5-120
 Purple	K5-127	K5-131
 Bronze	K5-128	K5-132



470 x 82 x 74 mm



Color	Code	Code
 Black	K5-106	K5-121
 Red	K5-107	K5-122
 Blue	K5-108	K5-123
 Green	K5-109	K5-124
 Yellow	K5-110	K5-125
 Grey	K5-111	K5-126
 Purple	K5-129	K5-133
 Bronze	K5-130	K5-134



BASKETS

The baskets are the main supplementary components of container systems and they are necessary for a full set container. Hermann Müller has focused on 2 main models in basket production. These models are wire basket and perforated sheet basket. Hermann Müller has the model and sizes of baskets in its standard production appealing to all container model and sizes. Also, it ensures basket production in demanded sizes besides standard production.

The standard diameter of the wire used in basket production is 1 mm and mesh distance is 4 mm. But this distance can also be arranged according to the special demands. Besides, Hermann Müller manufactures fine mesh baskets for small instruments, laundry baskets and endoscopic baskets. These baskets can also be produced in demanded sizes and mesh distances.

Please contact our company for any special production basket.

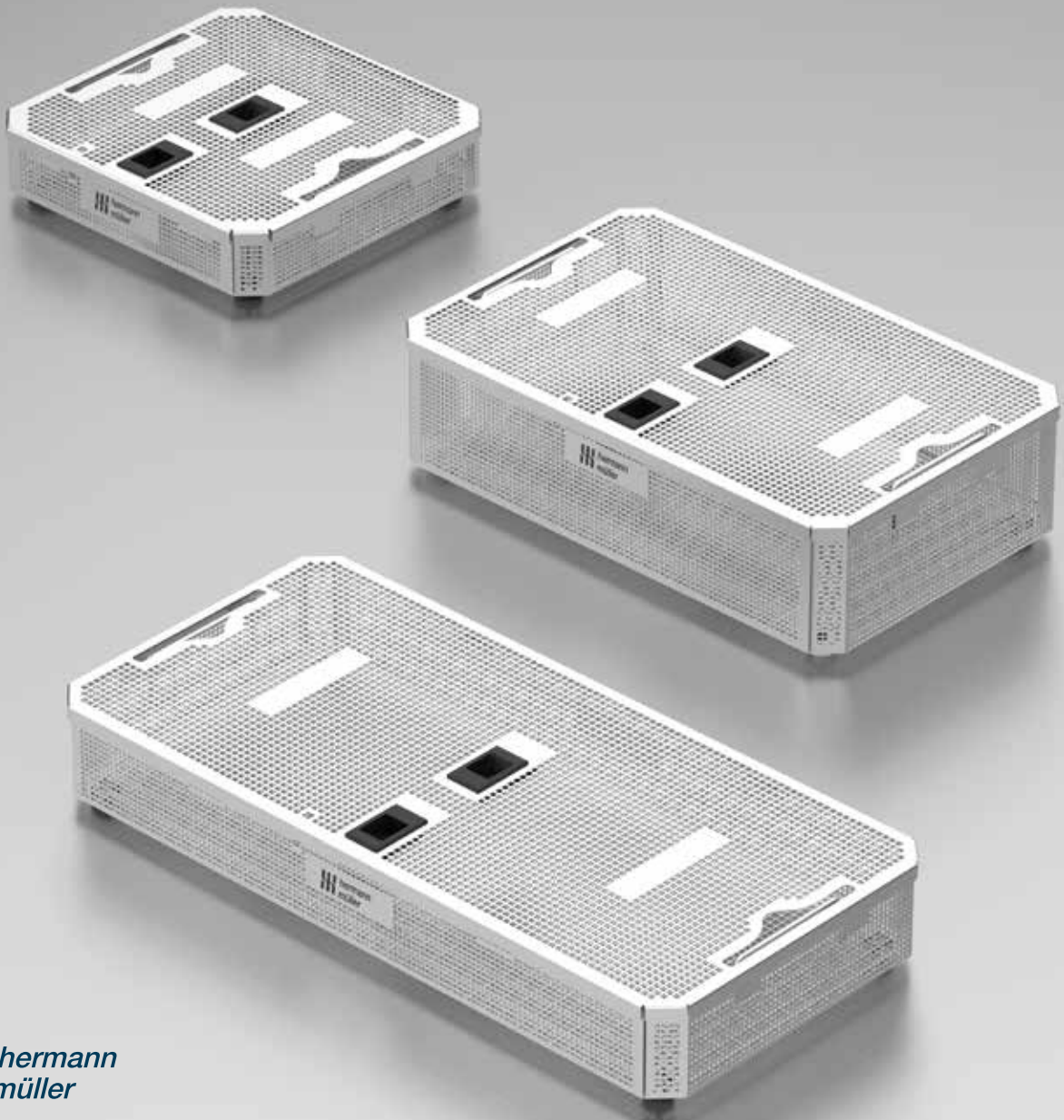



For 1/1 Models



Box
Stand Height: 10 mm



Code	Outside Dimension
K3-740	540 x 253 x 40 mm
K3-741	540 x 253 x 60 mm
K3-742	540 x 253 x 80 mm
K3-743	540 x 253 x 110 mm

Code	Outside Dimension
K3-744	485 x 253 x 40 mm
K3-745	485 x 253 x 60 mm
K3-746	485 x 253 x 80 mm
K3-747	485 x 253 x 110 mm

For 1/1 Models



Lid

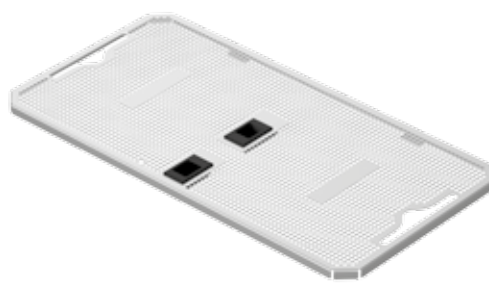

Code	Dimension
K3-760	542 x 256 x 4 mm

Code	Dimension
K3-761	487 x 256 x 4 mm

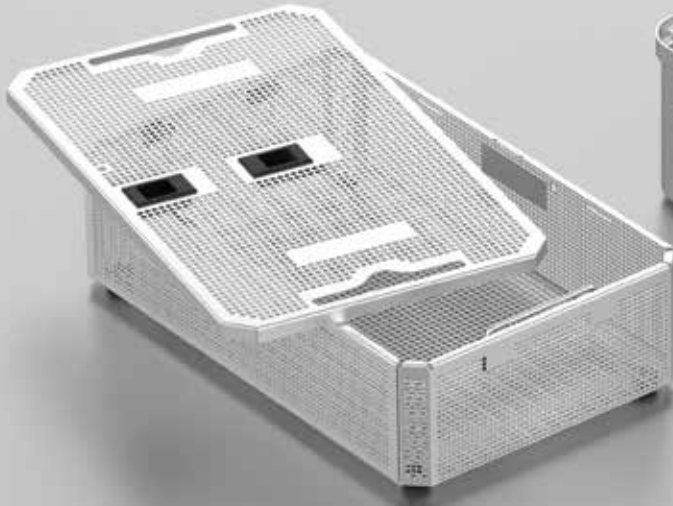

For 3/4 Models



Box
Stand Height: 10 mm

For 1/2 Models



Box
Stand Height: 10 mm

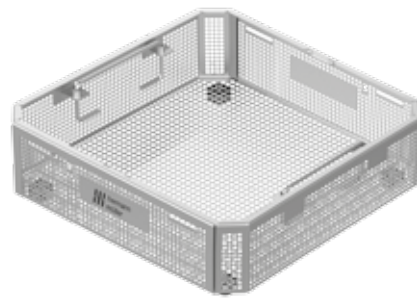

Code **Outside Dimension**

K3-748 405 x 253 x 40 mm

K3-749 405 x 253 x 60 mm

K3-750 405 x 253 x 80 mm

K3-751 405 x 253 x 110 mm

Code **Outside Dimension**

K3-752 244 x 253 x 40 mm

K3-753 244 x 253 x 60 mm

K3-754 244 x 253 x 80 mm

K3-755 244 x 253 x 110 mm

For 3/4 Models



Lid

For 1/2 Models



Lid

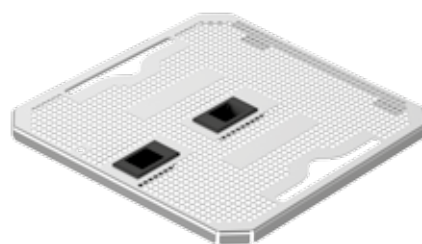
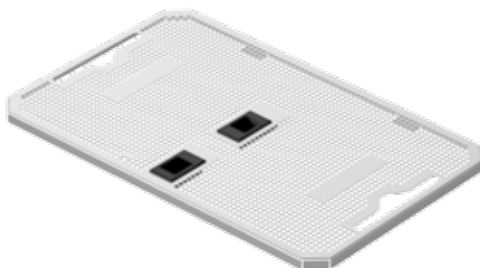

Code **Outside Dimension**

K3-762 407 x 256 x 4 mm

Code **Outside Dimension**

K3-763 247 x 256 x 4 mm



For Extra Large Models



Box
Stand Height: 10 mm



Code	Outside Dimension
K3-705	533 x 340 x 40 mm
K3-706	533 x 340 x 60 mm
K3-707	533 x 340 x 80 mm
K3-708	533 x 340 x 110 mm

For Extra Long Models



Box
Stand Height: 10 mm



Code	Outside Dimension
K3-711	665 x 253 x 40 mm
K3-712	665 x 253 x 60 mm
K3-713	665 x 253 x 80 mm
K3-714	665 x 253 x 110 mm

For Extra Large Models



Lid



Code	Outside Dimension
K3-709	539 x 346 x 4 mm

For Extra Long Models



Lid



Code	Outside Dimension
K3-710	667 x 256 x 4 mm

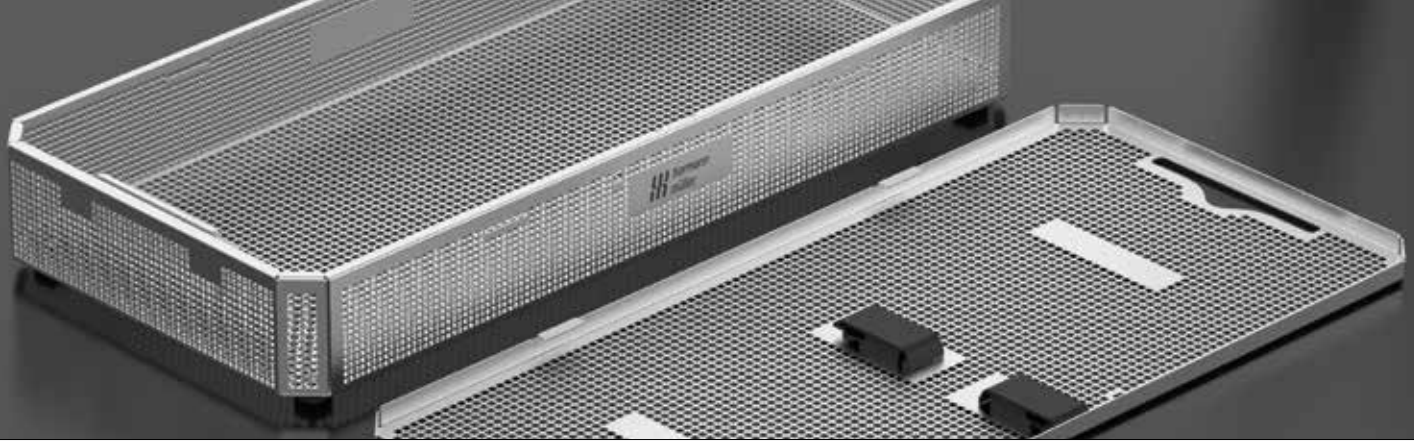

For Large Dental Models



Box
Stand Height: 10 mm



Code	Outside Dimension
K3-771	320 x 220 x 60 mm
K3-772	320 x 220 x 80 mm
K3-773	320 x 220 x 110 mm

For Dental Models



Box
Stand Height: 5 mm



Code	Outside Dimension
K3-756	275 x 175 x 45 mm
K3-757	275 x 175 x 105 mm

For Mini Models



Box
Stand Height: 5 mm



Code	Outside Dimension
K3-758	265 x 125 x 55 mm

For Large Dental Models



Lid



Code	Outside Dimension
K3-770	322 x 223 x 4 mm

For Dental Models



Lid



Code	Outside Dimension
K3-764	277 x 178 mm

For Mini Models



Lid

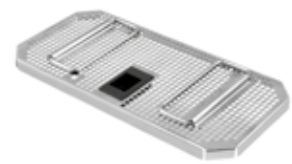

Code	Outside Dimension
K3-765	267 x 127 mm

Stand



Code K3-767 Height 20 mm



Code K3-768 Height 10 mm



Code K3-766 Height 5 mm

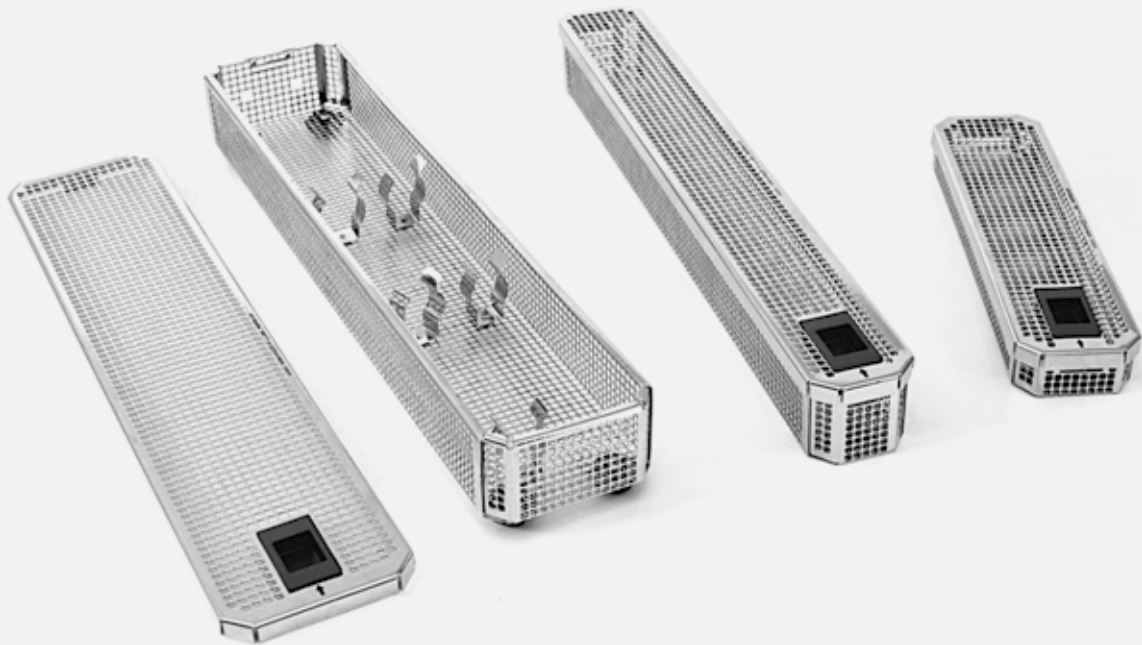

Our wire mesh and perforated sheet baskets can be manufactured in any size.

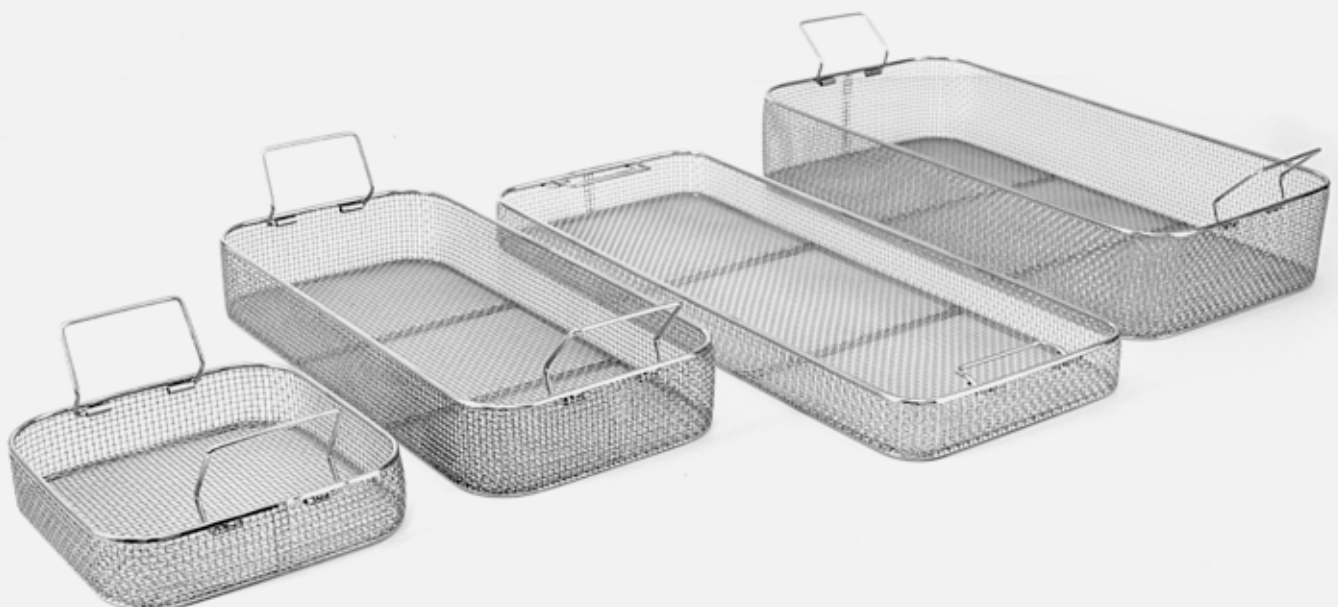

Please contact for detailed information



Code	Outside Dimension
K3-787	138 x 124 x 48 mm

Without silicone fixation systems



Code	Outside Dimension
K3-788	146 x 46 x 28 mm

Without silicone fixation systems



Code	Outside Dimension
K3-789	86 x 46 x 28 mm

Without silicone fixation systems
Bottom 2 mm, lid 4 mm perforation



Code	Outside Dimension
K3-786K	191 x 130 x 36 mm

Basket with silicone fixation systems
Holds 12 instruments with Ø 5 mm



Code	Outside Dimension
K3-786	191 x 130 x 34 mm

Without silicone fixation systems



Code	Outside Dimension
K3-790K	186 x 72 x 24 mm

Tray with silicone fixation system.
Holds 5 instruments.



Code	Outside Dimension
K3-791K	186 x 99 x 24 mm

Tray with silicone fixation system.
Holds 7 instruments.



Code	Outside Dimension
K3-792K	186 x 137 x 24 mm

Tray with silicone fixation system.
Holds 10 instruments.



Code	Outside Dimension
K3-793K	286 x 192 x 34 mm

Tray with silicone fixation system.
Holds 20 instruments.

BASKETS

STERILIZATION CONTAINER SYSTEMS

DENTAL BASKETS & TRAYS ▾

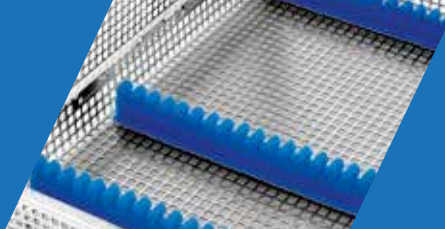

Code	Outside Dimension
K3-780K	274 x 180 x 34 mm

Basket with silicone fixation systems
Holds 17 instruments with Ø 5 mm



Code	Outside Dimension
K3-780	274 x 180 x 32 mm

Without silicone fixation systems



Code	Outside Dimension
K3-781K	274 x 180 x 44 mm

Basket with silicone fixation systems
Holds 17 instruments with Ø 5 mm



Code	Outside Dimension
K3-781	274 x 180 x 42 mm
K3-782	274 x 180 x 62 mm

Without silicone fixation systems



Code	Outside Dimension
K3-783K	274 x 88 x 46 mm

Basket with silicone fixation systems
Holds 8 instruments with Ø 5 mm



Code	Outside Dimension
K3-784K	240 x 76 x 30 mm

Basket with blue silicone mat



Code	Outside Dimension
K3-785K	188 x 86 x 36 mm

Basket with silicone fixation systems
Holds 8 instruments with Ø 5 mm



Code	Outside Dimension
K3-785	188 x 86 x 32 mm

Basket with blue silicone mat

Mesh grid

Actual Size

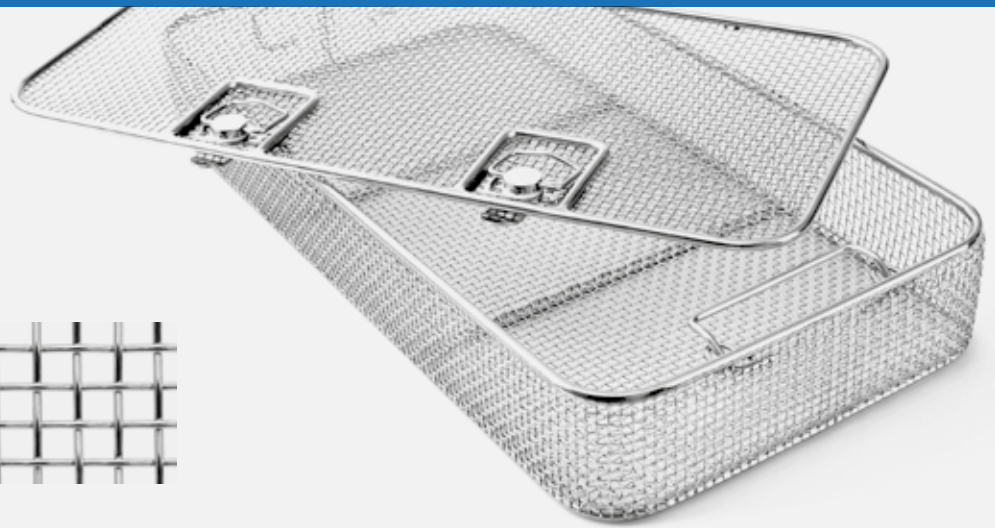
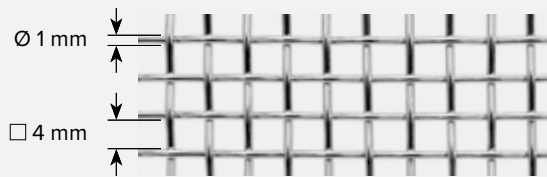

For 1/2 Models



Box



Code	Outside Dimension
K2-490	246 x 246 x 30 mm
K2-491	246 x 246 x 50 mm
K2-492	246 x 246 x 70 mm
K2-493	246 x 246 x 100 mm



Lid

Code	Outside Dimension
K3-1045	246 x 246 mm

For 3/4 Models



Box



Code	Outside Dimension
K2-1500	405 x 245 x 30 mm
K2-1501	405 x 245 x 50 mm
K2-1502	405 x 245 x 70 mm
K2-1503	405 x 245 x 100 mm



Lid

Code	Outside Dimension
K3-1034	405 x 245 mm

For 1/1 Models



Code	Outside Dimension
K2-450	480 x 245 x 30 mm
K2-451	480 x 245 x 50 mm
K2-452	480 x 245 x 70 mm
K2-453	480 x 245 x 100 mm

For 1/1 Models



Code	Outside Dimension
K2-460	540 x 245 x 30 mm
K2-461	540 x 245 x 50 mm
K2-462	540 x 245 x 70 mm
K2-463	540 x 245 x 100 mm



Code	Outside Dimension
K3-1024	485 x 245 x 5 mm



Code	Outside Dimension
K3-1014	540 x 245 x 5 mm

For Large Dental Models



Code	Outside Dimension
K3-2000	323 x 222 x 50 mm
K3-2001	323 x 222 x 70 mm
K3-2002	323 x 222 x 100 mm



For Extra Large Models



Code	Outside Dimension
K2-1701	533 x 337 x 50 mm
K2-1702	533 x 337 x 70 mm
K2-1703	533 x 337 x 100 mm



For Extra Long Models



Code	Outside Dimension
K2-1801	665 x 250 x 50 mm
K2-1802	665 x 250 x 70 mm
K2-1803	665 x 250 x 100 mm



Code	Outside Dimension
K3-2013	323 x 222 x 5 mm



Code	Outside Dimension
K3-1707	533 x 337 x 5 mm



Code	Outside Dimension
K3-1807	665 x 250 x 5 mm

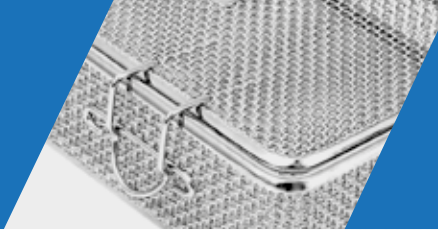

Mesh Grid



Box With Lid



Box

Actual Size

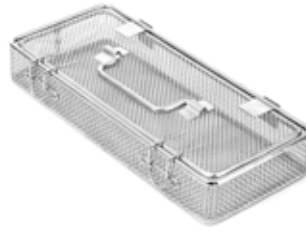
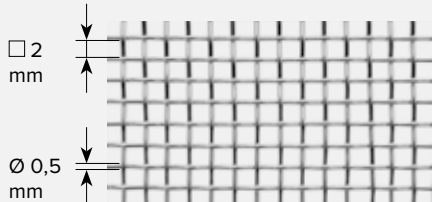

Code	Outside Dimension
K2-993	268 x 127 x 47 mm



Code	Outside Dimension
K3-1073	268 x 117 x 43 mm

Mesh Grid



Box With Lid



Box

Actual Size

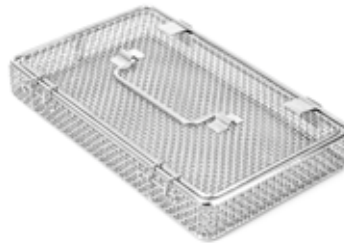
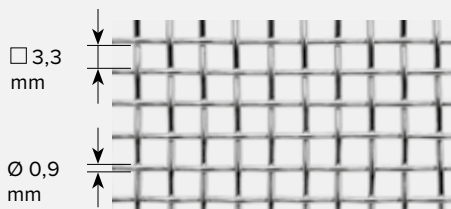

Code	Outside Dimension
K3-611	270 x 175 x 45 mm



Code	Outside Dimension
K3-1070	270 x 170 x 38 mm



Box With Lid



Box



Code	Outside Dimension
K2-995	175 x 153 x 35 mm



Code	Outside Dimension
K3-1079	175 x 144 x 30 mm

BASKETS

STERILIZATION CONTAINER SYSTEMS

SMALL FINE MESH BASKETS WITH LID
WIRE BASE

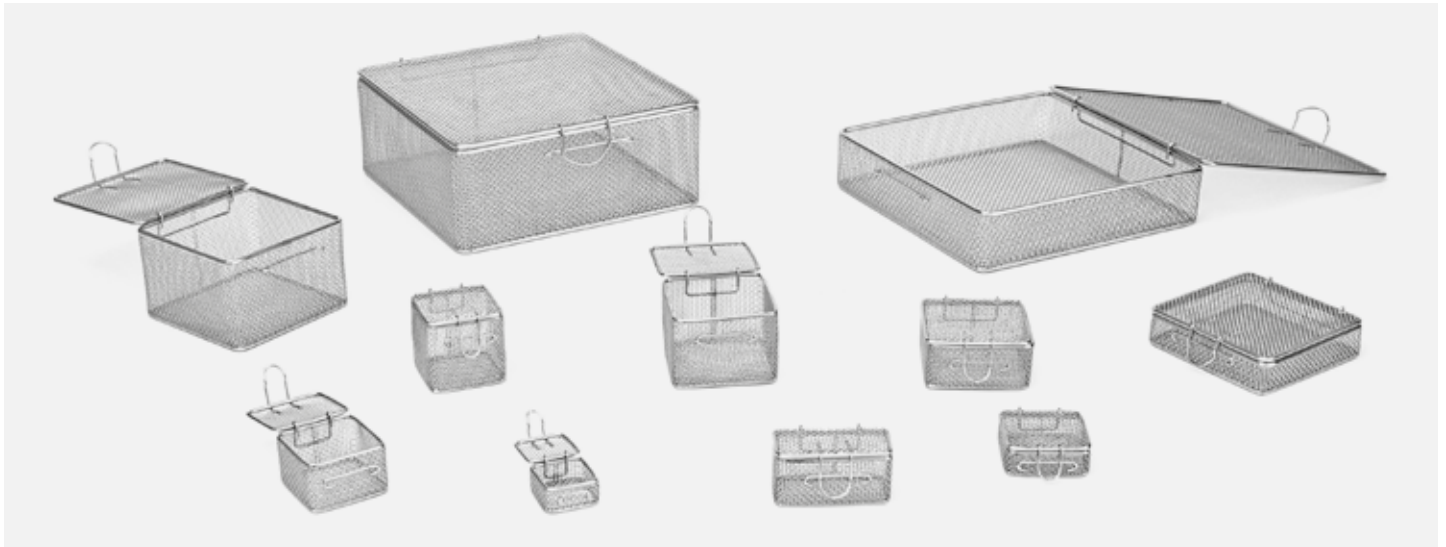

Mesh Grid

Actual Size

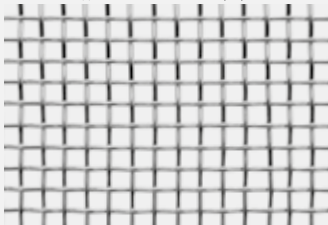
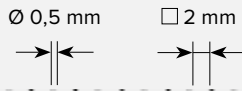

Box With Lid

Code	Outside Dimension
K3-1100	30 x 30 x 30 mm
K3-1101	40 x 40 x 20 mm
K3-1102	40 x 40 x 40 mm
K3-1103	60 x 60 x 20 mm
K3-1104	60 x 60 x 40 mm
K3-1105	60 x 60 x 60 mm
K3-1106	80 x 80 x 20 mm
K3-1107	80 x 40 x 40 mm
K3-1108	80 x 80 x 40 mm



Box With Lid

Code	Outside Dimension
K3-1109	80 x 80 x 60 mm
K3-1110	80 x 80 x 80 mm
K3-1111	100 x 100 x 10 mm
K3-1112	120 x 120 x 30 mm
K3-1113	120 x 120 x 60 mm
K3-1114	120 x 120 x 80 mm
K3-1115	240 x 240 x 30 mm
K3-1116	240 x 240 x 60 mm
K3-1117	240 x 240 x 80 mm
K3-1118	240 x 240 x 100 mm

WIRE BASE



Code	Outside Dimension
K2-440	545 x 255 x 30 mm



Code	Outside Dimension
K2-1522	405 x 255 x 30 mm

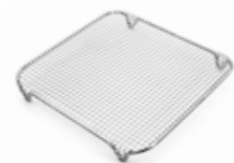

Code	Outside Dimension
K2-482	255 x 255 x 30 mm

LAUNDRY BASKETS



Code	Outside Dimension
K3-1080	600 x 400 x 150 mm
K3-1081	600 x 400 x 300 mm

Code	Outside Dimension
K3-1085	600 x 400 x 150 mm
K3-1086	600 x 400 x 300 mm

WIRE NET BASKETS



Code	Outside Dimension
K3-1200	250 x 170 x 70 mm
K3-1201	340 x 250 x 70 mm
K3-1202	450 x 340 x 70 mm

Code	Outside Dimension
K3-1203	250 x 170 mm
K3-1204	340 x 250 mm
K3-1205	450 x 340 mm

STE BASKETS



Standard

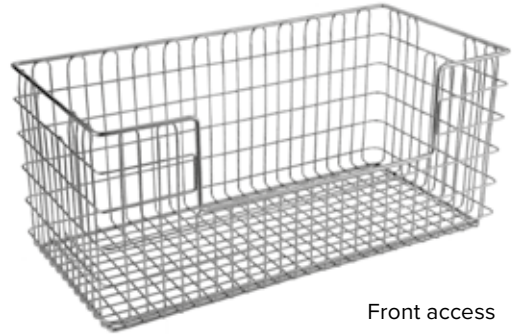

Front access

Code	Outside Dimension
K3-1206	575 x 280 x 135 mm
K3-1207	575 x 280 x 265 mm

Code	Outside Dimension
K3-1208	575 x 280 x 265 mm

SPRI BASKETS



Double Frame with Folding Handle

With Single Frame



Code	Outside Dimension
K3-1210	585 x 395 x 100 mm
K3-1211	585 x 395 x 195 mm

Code	Outside Dimension
K3-1230	600 x 300 x 40 mm
K3-1231	600 x 300 x 50 mm
K3-1232	600 x 300 x 100 mm
K3-1233	600 x 300 x 130 mm
K3-1234	600 x 300 x 150 mm
K3-1235	600 x 300 x 180 mm
K3-1236	600 x 300 x 200 mm
K3-1237	600 x 400 x 100 mm
K3-1238	600 x 400 x 130 mm
K3-1239	600 x 400 x 150 mm
K3-1240	600 x 400 x 180 mm
K3-1241	600 x 400 x 200 mm

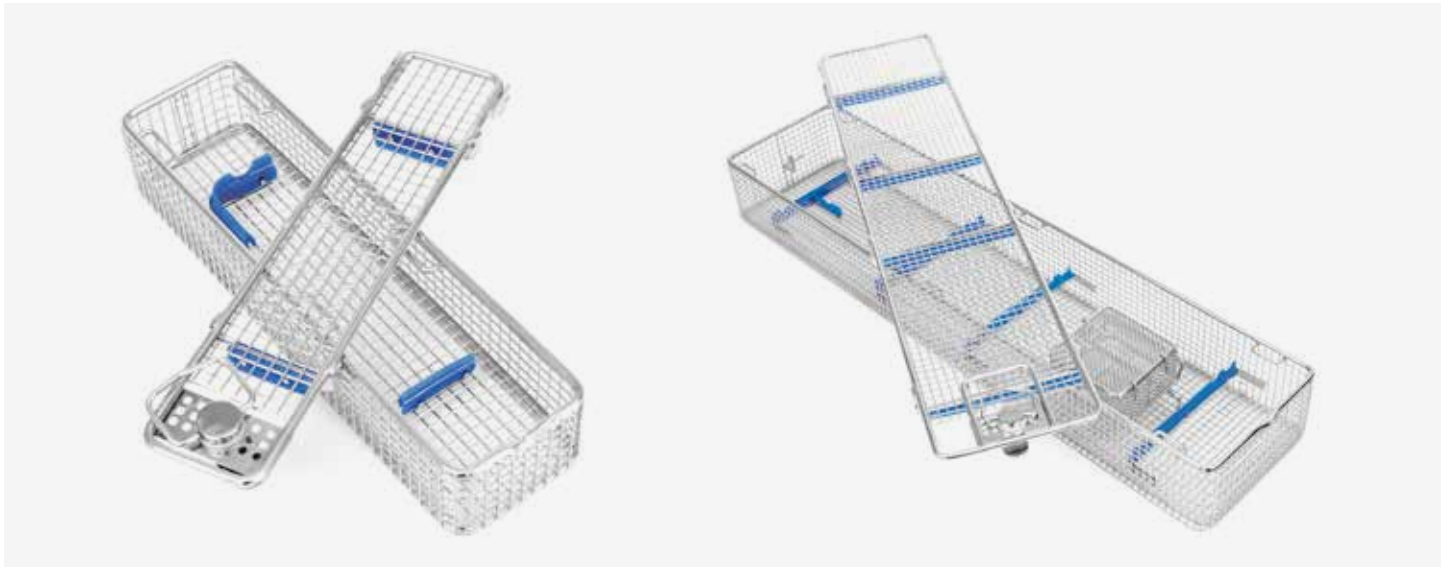

304 ss wire mesh

Actual Size

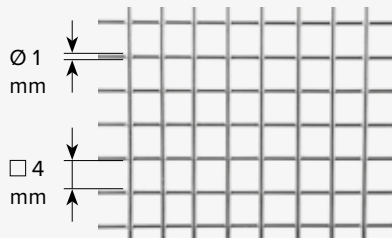

Code	Outside Dimension
K3-1050	670 x 80 x 52 mm
K3-1051	460 x 80 x 52 mm
K3-1052	290 x 80 x 52 mm



Code	Outside Dimension
K3-1062	640 x 150 x 77 mm

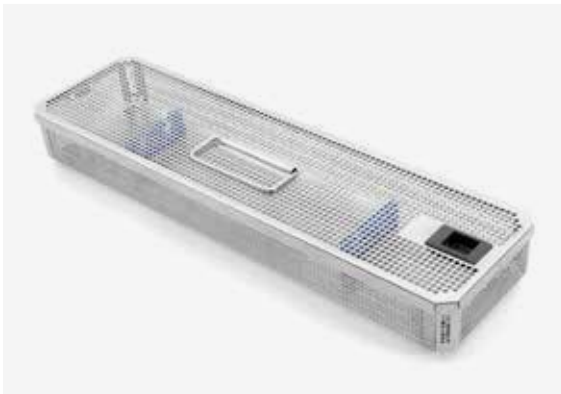

Code	Outside Dimension
K3-1054	492 x 134 x 55 mm
K3-1055	492 x 134 x 65 mm

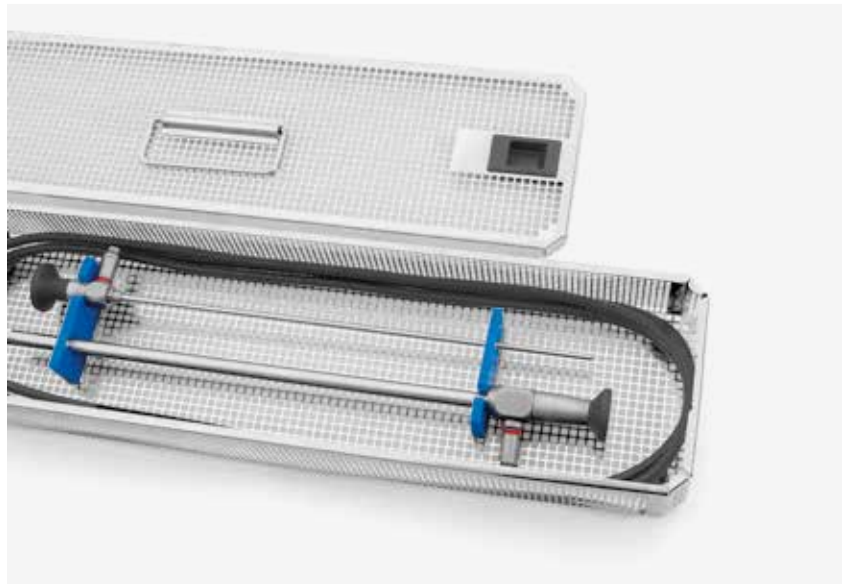

BASKETS

STERILIZATION CONTAINER SYSTEMS

ALUMINIUM BASKET, WITH LID ▾



Code	Outside Dimension
------	-------------------

K3-1119	245 x 130 x 55 mm
---------	-------------------



Code	Outside Dimension
------	-------------------

K3-1120	245 x 130 x 70 mm
---------	-------------------



Code	Outside Dimension
------	-------------------

K3-1121	245 x 130 x 105 mm
---------	--------------------



WASHER TUBE FOR K-WIRES

The Hermann Müller washer tube systems are designed in order to safely keep, healthfully wash and sterilize the K-Wires used especially in orthopedic (trauma) surgery.



Code	Outside Dimension
K4-1051	460 x 100 x 64 mm

K-Wires stainless steel basket with lid.

Code	Outside Dimension
K4-1052	265 x 72 x 64 mm

K-Wires stainless steel basket with lid.

WASHER TUBE FOR K-WIRES

The Hermann Müller washer tube systems are designed in order to safely keep, healthfully wash and sterilize the K-Wires used especially in orthopedic (trauma) surgery. The Hermann Müller washer tubes systems have a special design for getting maximum efficiency. The dividing part inside the tube provides protection of 4 different diameter wires without intermixing. With the help of inner tube placed in the middle of the divider, the high pressure water coming of the washer machine flows from inside to outside. By this way, the wires inside the tube are washed by inside-out and outside-in flow and the disinfection process is completed efficiently.



- The system has 2 different lengths as option.
- Every tube has 4 different tanks for 4 different diameter wires.
- The system has been designed suitable for 12 different diameter from 0,6 mm to 3 mm.

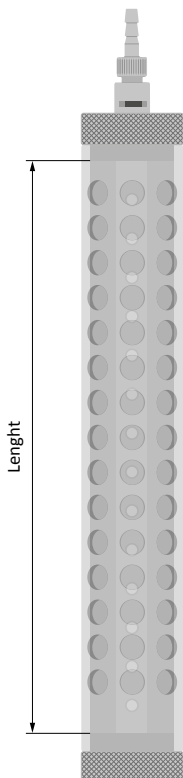

Code	Length	Suitable Wire Diameters
KA-100	150 mm	Ø 0,60 mm Ø 0,80 mm Ø 1,00 mm Ø 1,20 mm
KB-100	150 mm	Ø 1,25 mm Ø 1,40 mm Ø 1,50 mm Ø 1,60 mm
KC-100	150 mm	Ø 1,80 mm Ø 2,00 mm Ø 2,50 mm Ø 3,00 mm
KLA-100	300 mm	Ø 0,60 mm Ø 0,80 mm Ø 1,00 mm Ø 1,20 mm
KLB-100	300 mm	Ø 1,25 mm Ø 1,40 mm Ø 1,50 mm Ø 1,60 mm
KLC-100	300 mm	Ø 1,80 mm Ø 2,00 mm Ø 2,50 mm Ø 3,00 mm

ACCESSORIES

MODULAR AUTO LOCK MECHANISM

What Is Auto Lock Mechanism

Auto lock mechanism is a heat-sensitive automatic locking system developed in order to ease sterilization control by R&D department. Modular auto lock system designed to be usable with different container systems.

This system has been developed in accordance with the requirements of sterilization to be used in a steam autoclave for our container systems. Auto lock is a system designed in reusable property instead of disposable plastic products that are used as security locks in containers. The system has been tested in our own facilities 5000 cycles and has successfully passed all tests. Minimum expected life of the system is 5000 sterilizations. During this time system is usable without the need for any maintenance or service.

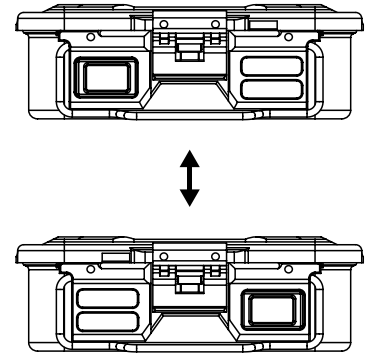

Code

K1-900 (2 pcs)

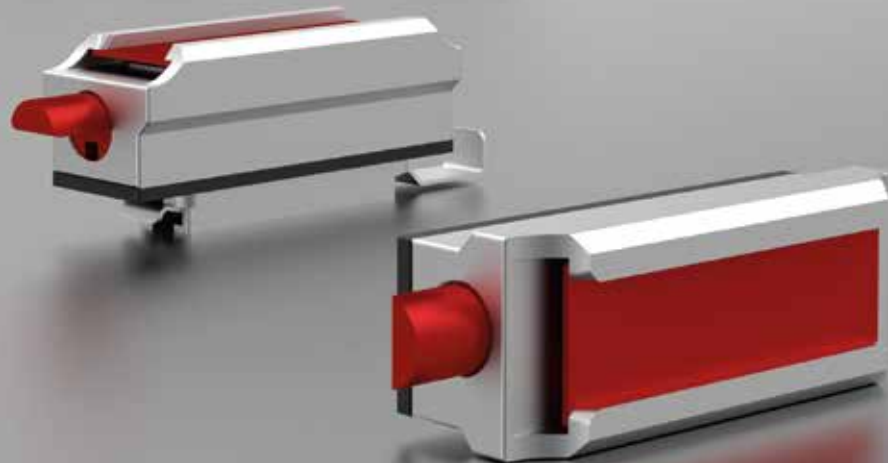

How does Auto Lock Mechanism Work?

The average temperature in the autoclave during sterilization is at the level of 135 ° C degrees.

As the temperature in the autoclave begins to rise above 100 degrees, automatic locking mechanism located on the box is activated. When the mechanism is activated, the red movable locking shaft in it is going forward (Picture 1). When the movable locking shaft is going forward, it blocks the locking mechanism in lid and so it prevents uncontrolled opening of the lid.

The process of the system becoming inactive is as following: After sterilization process has been completed and container has been removed from the autoclave, the container and Auto Lock system are allowed to cool between 5 and 10 minutes. Then the red movable locking shaft is pushed back with the help of fingers (Picture 3). Thus, lid closure of the container ceases to be blocked and comes to opened position.

When the container enters into each sterilization, these processes are repeated in the same manner.

When the user sees that Auto Lock mechanism is activated (Picture 1), he/she can understand that the container has entered to the sterilization process. If Auto lock mechanism is inactive (Picture 2), it means that this container has been previously opened.

Picture 1 (Closed Position)

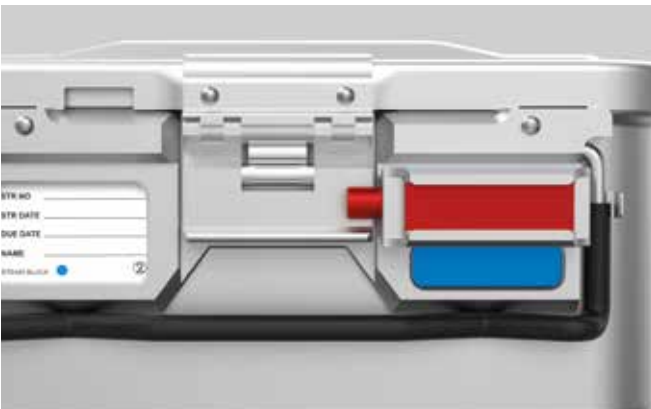

Picture 2

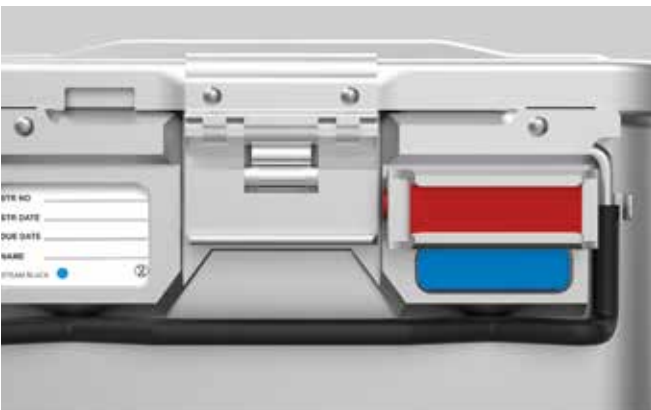

WARNING: It's possible to move the movable shaft with only the effect of temperature. It's not possible under normal conditions to activate (to be brought into locked position) lock mechanism.

What Are The Advantages Of Modular Auto Mechanism?

Because of system being reusable, it is more economical when you compare with plastic security seal usage.

System is modular, so it can be usable with different brand products. In this reason, so many users can make use of system advantages.

After the usage of disposable products, plastic material harms the nature. Because of reusable property of auto lock mechanism and because of recycling raw material inside, system does not harm the nature.

Disposable products have many disadvantages such as purchasing, storage and inventory tracking. Auto Lock mechanism saves the user from this workload and cost.

Disposable products must be attached to the (2) container(s) prior to each sterilization and this leads to loss of time for the employees.

Auto Lock Mechanism removes the difficulties faced during the use of security seals. In breakdown condition, because of product is not fixed on the container, system can be easily serviceable or changeable so container does not needs replacing.

Picture 3

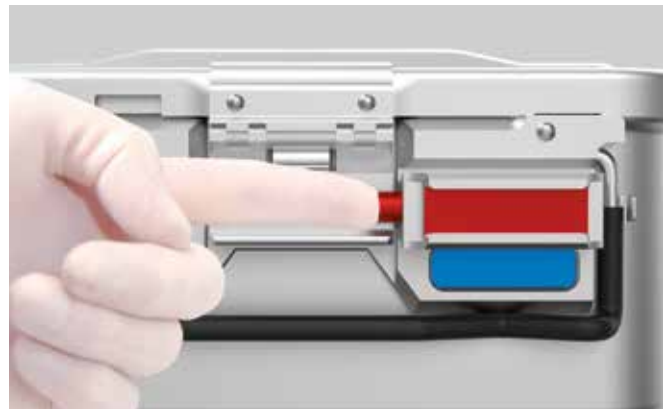

Picture 4



All our container systems with Auto Lock mechanism are designed to be used also with plastic security seal when necessary (Picture 4).

MODULAR AUTO LOCK MECHANISM



Picture 1



Locking clamp should be removed from the groove before assembly.

Picture 2



Then it should be placed to the container label part as shown picture.

Picture 3



When you sure that product is snug, locking clamp should be placed through the arrow direction.

Picture 4



Please be sure that locking stamp is forwarded to the end of the clamp groove and it is locked.



Lock mechanism should be in open position for the disassembly process (Picture 2).

It is not possible to make disassembly on closed position (Picture 1).

When you sure that lock mechanism is on open position, locking clamp can be removable by pulling backward through the reverse direction of the locking direction.

WINDOW FOR EMULATING INDICATOR

We continue to produce solution for the sterilization management requirements with our 25 years of experience in medical industry. For this purpose, we have developed emulating indicator window for the sterilization container systems.

Aim Of The Window For Emulating Indicator

Emulating indicators are used for the load sterilization monitorization while surgical instruments are loaded to containers in central sterilization services department (CSSD).

During standard container usage it is not possible to see indicator results without opening the lid. When set is decided to use in surgery if result is negative and also if there is no alternative set, surgery is delaying and problems occurs in implementations.

Result of the emulating indicator can observed after cycle easily from the window on the container case. In negative conditions, sterilization processes are repeated before send set to usage. By this way waste of time prohibited and it can help to avoid troubles before start.

Window For Emulating Indicator

- Transparent PPSU polymer material is used on window part of the system which is suitable to autoclave. PPSU polymer material has resistance to scoring and impact also it is a special material which has heat resistance up to 330°
- Silicon joint is used between window and box to avoid sterilization risk inside the container and security is provided %100 by 4 pieces rivet connection.
- All other parts used in the system is manufactured from anodized aluminum and stainless steel.
- Indicator is designed to place the box from two directions. Also there is a spring mechanism to immobilize indicator because of the pressure inside the indicator placed sections. This spring mechanism and the immobilization property from the two side of indicator are provided to use different branded indicators to use in this system together.



TÜRK PATENT ENSTİTÜSÜ
No: 2014-GE-49085



NO RISK...



Usage Of Window For Emulating Indicator

Emulating indicator before placing materials to sterilize inside the box for the sterilization purpose is placed inside the box as below.

.....



When you placed indicator band inside the box, you should be sure that placed references and indicator should appears. You should specify the suitable position by reciprocating motions or rotating reverse the indicator band.

.....



After you placed indicator band fairly, you can start sterilization process by placing materials to sterilize after closing the lid.

ACCESSORIES

STERILIZATION CONTAINER SYSTEMS



Label (Papers)

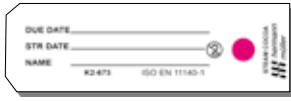

Code K2-673

100 pcs. With indicator.

For small size and special containers



Code K2-672

100 pcs. With indicator.

For full and Half size containers



Identification Labels (Aluminium)

Thoracotomy

Basic Set

Basic Set

Thoracotomy

Thoracotomy

Basic Set

Basic Set

Thoracotomy

Color	Code
Red	K2-700
Blue	K2-701
Green	K2-702
Yellow	K2-703
Grey	K2-704
Black	K2-705
Purple	K2-706
Bronze	K2-707

Coloured identification labels
Engraved to your specifications
Maximum 16 letters



Identification (Aluminium)

Grey coloured recommended for use in Sterrad. Color fading By effect of Hydrogen Peroxide Gas Plasma on other colors.



Label Holder

Color	Code
Red	K2-560
Blue	K2-561
Green	K2-562
Yellow	K2-563
Grey	K2-564
Black	K2-565
Purple	K2-566
Bronze	K2-567

Labels

Color	Code
Red	K2-570
Blue	K2-571
Green	K2-572
Yellow	K2-573
Grey	K2-574
Black	K2-575
Purple	K2-576
Bronze	K2-577

Coloured identification labels Engraved to your specification





Code K2-663 *Blue*

100 pcs. with indicator.
made of plastic



Code K2-664 *Blue*

100 pcs. made of plastic



Code K2-661 *Blue*

100 pcs. with number.
made of plastic



Code K2-662 *Red*

100 pcs. with indicator.
made of plastic



Code K2-660 *Red*

100 pcs. made of plastic



Code K2-665 *Red*

100 pcs. with number.
made of plastic



▽ PLASMA MODEL ACCESSORIES

SECURITY SEAL



Code K2-663Z *Blue*

100 pcs. with indicator.
For hydrogen peroxide
plasma sterilization

LABEL



Code K2-672Z

100 pcs. with indicator.
For hydrogen peroxide
plasma sterilization



Code K2-673Z

100 pcs. with indicator.
For hydrogen peroxide
plasma sterilization

FILTERS for hydrogen peroxide plasma sterilization

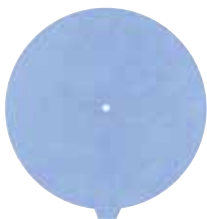

Code K2-741Z

Diameter: 184 mm

Single use 100 pcs.
for 1/1, 3/4, 1/2 model

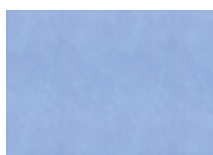

Code K3-615Z

Dimension: 235 x 165 mm

Single use 100 pcs.
for Dental model



Code K2-761Z

Dimension: 235 x 120 mm

Single use 100 pcs.
for Mini model



Code K2-780Z

Dimension: 130 x 130 mm

Single use 100 pcs.
for 1/2 Dental model



Code K2-759Z

Dimension: 235 x 105 mm

Single use 100 pcs.
for Endo model



Paper Filter Paper Filter Teflon Filter Teflon Filter (For B3 PTFE System)

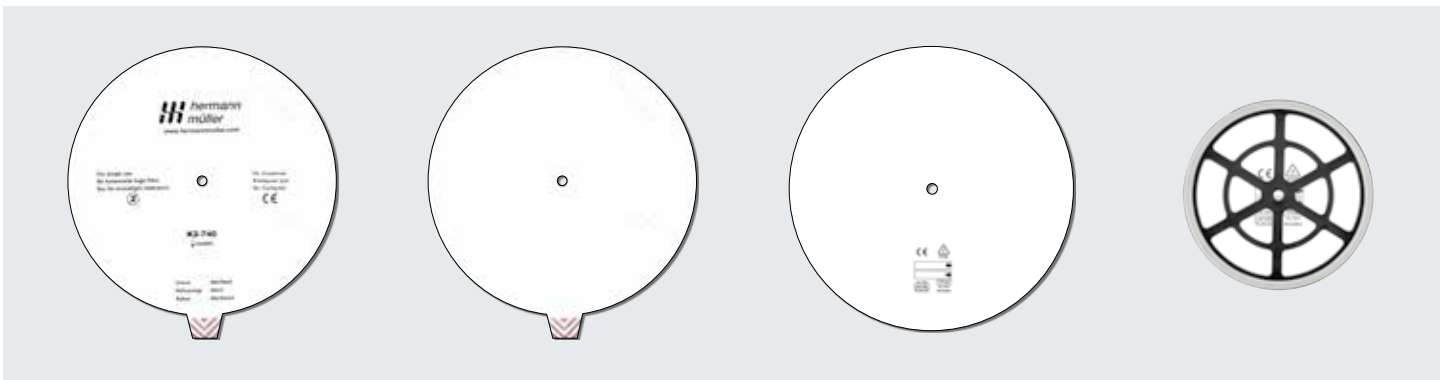

Code K2-740
Diameter 184 mm

Single use 100 pcs with indicator. Hermann Müller mark.

Code K2-741
Diameter 184 mm

Single use 100 pcs with indicator. No marking.

Code K2-742
Diameter 194 mm

Number of sterilization cycle < 2000

Code K2-745
Diameter 90 mm

Number of sterilization cycle < 2000 to be used with K1-970

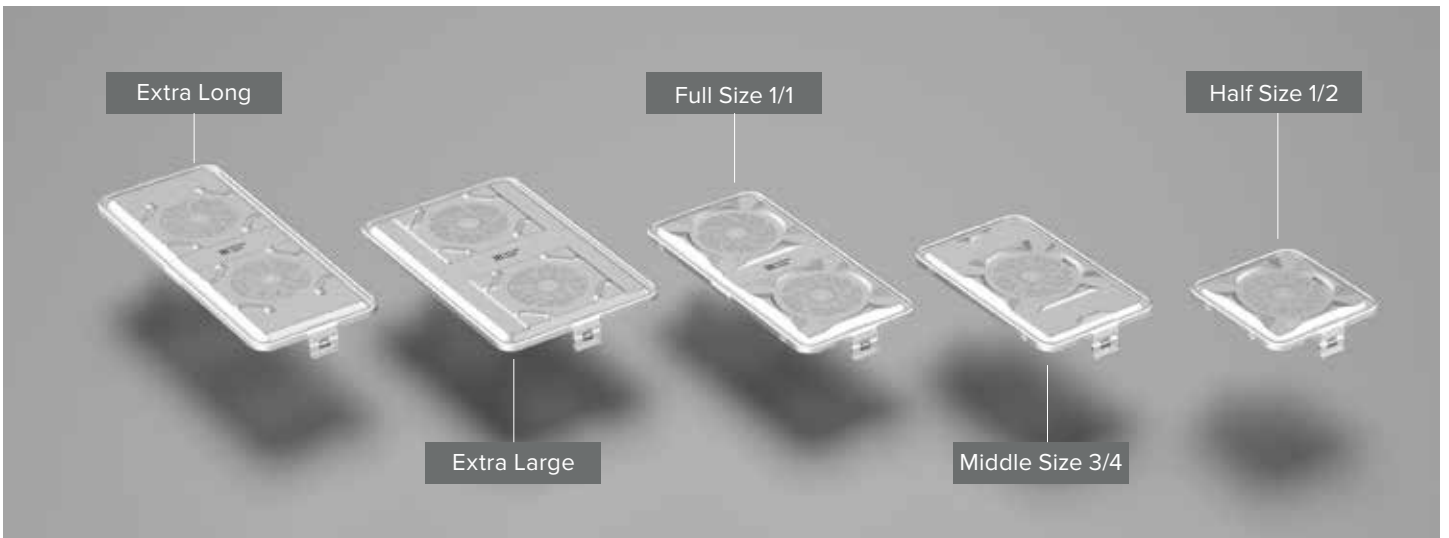

Paper Filter

Paper Filter

Teflon Filter

For Dental Model



Code K3-612

Dimension 235 x 165 mm

Single use 100 pcs with indicator. Hermann Müller mark.

Code K3-615

Dimension 235 x 165 mm

Single use 100 pcs with indicator. No marking.

Code K2-743

Dimension 215 x 145 mm

Number of sterilization cycle < 2000

Paper Filter

Paper Filter

Teflon Filter

For Mini Model



Code K2-760

Dimension 235 x 120 mm

Single use 100 pcs with indicator. Hermann Müller mark.

Code K2-761

Dimension 235 x 120 mm

Single use 100 pcs with indicator. No marking.

Code K2-744

Dimension 215 x 95 mm

Number of sterilization cycle < 2000

Paper Filter

Paper Filter

Teflon Filter

For 1/2 Dental Model

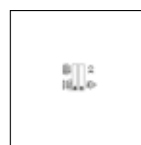

Code K2-781

Dimension 130 x 130 mm

Single use 100 pcs with indicator. Hermann Müller mark.

Code K2-780

Dimension 130 x 130 mm

Single use 100 pcs with indicator. No marking.

Code K2-782

Dimension 130 x 130 mm

Number of sterilization cycle < 2000

Paper Filter

Paper Filter

Teflon Filter

For Endo Model



Code K2-758

Dimension 235 x 105 mm

Single use 100 pcs
with indicator.
Hermann Müller mark.

Code K2-759

Dimension 235 x 105 mm

Single use 100 pcs
with indicator. No marking.

Code K2-744

Dimension 215 x 95 mm

Number of sterilization
cycle < 2000

FILTER RETAINERS



Code K2-720

Diameter 186 mm

Filter Retainer,
for 1/1, 3/4, 1/2, Extra large,
Extra long, Large dental



Code K2-1715

Dimension 247 x 172 mm

Filter Retainer,
for Dental model



Code K2-1716

Dimension 243 x 120 mm

Filter Retainer,
for Mini model



Code K2-1717

Dimension 162 x 144 mm

Filter Retainer,
for 1/2 Dental model

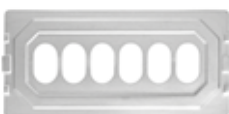

Code K2-1718

Dimension 243 x 105 mm

Filter Retainer,
for Endo model

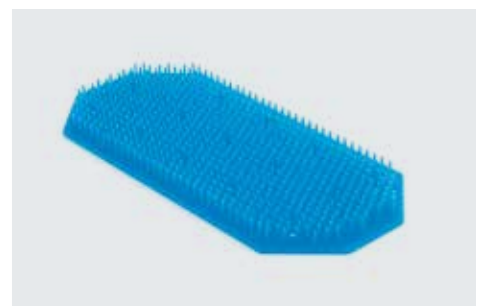
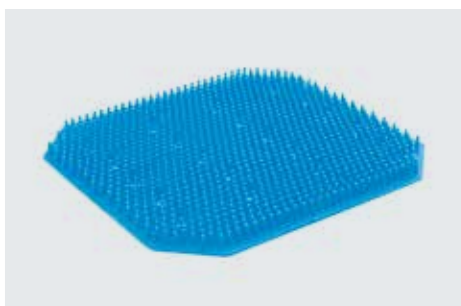
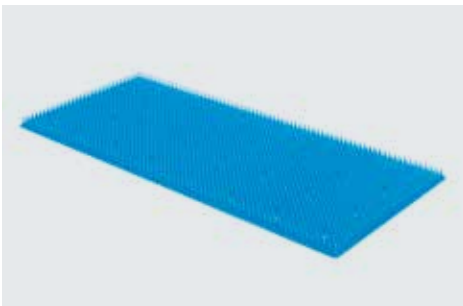
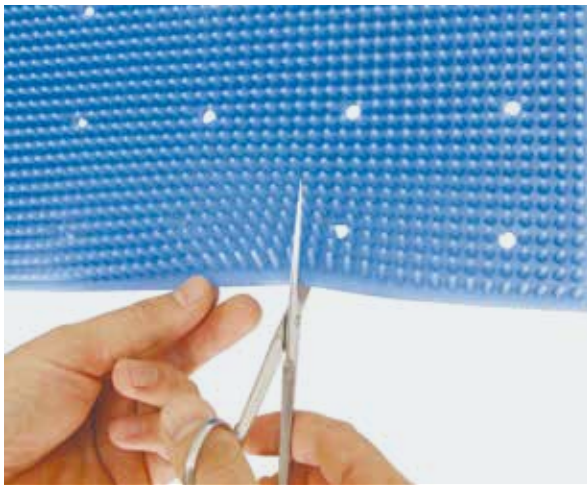

Code	Dimension
K2-519	160 x 135 mm
K2-520	275 x 125 mm
K2-521	250 x 235 mm
K2-522	340 x 230 mm (2 pcs)
K2-523	300 x 300 mm
K2-524	380 x 230 mm

Code	Dimension
K2-525	440 x 230 mm
K2-526	520 x 230 mm
K2-527	230 x 220 mm
K2-528	475 x 230 mm
K2-529	260 x 180 mm
K2-532	280 x 200 mm

SILICONE MESH MATS

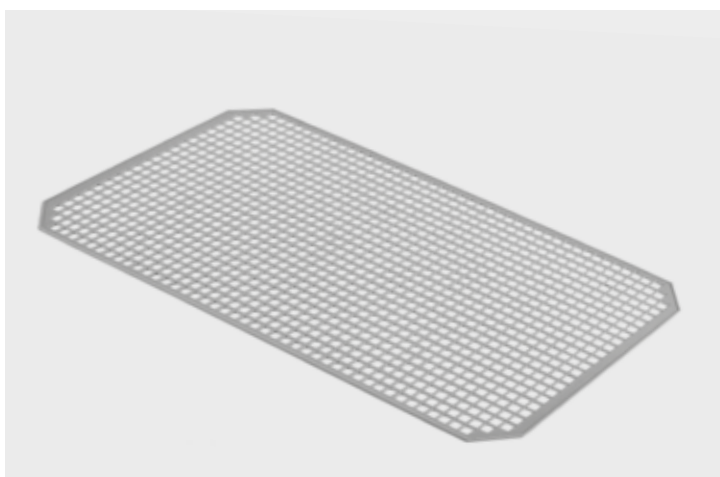

Code	Dimension
K2-530	250 x 240 mm
K2-531	485 x 250 mm
K2-533	534 x 247 mm
K2-534	395 x 245 mm
K2-535	527 x 335 mm
K2-536	658 x 247 mm

Silicone Mesh Mat,
Enables surgical instruments to be stored
without slip and dry well.



Code	Model	Size
K3-948	Large Dental Silicone Gasket	118 cm
K3-949	1/2 Dental Silicone Gasket	72 cm
K3-950	Mini Silicone Gasket	77 cm
K3-951	Dental Silicone Gasket	89 cm
K3-952	Flat Silicone Gasket	101 cm
K3-953	1/2 Silicone Gasket	101 cm
K3-954	3/4 Silicone Gasket	136 cm
K3-955	1/1 Silicone Gasket	158 cm
K3-956	Extra Large Silicone Gasket	180 cm
K3-957	Extra Long Silicone Gasket	185 cm
K3-958	Endo Silicone Gasket	130 cm

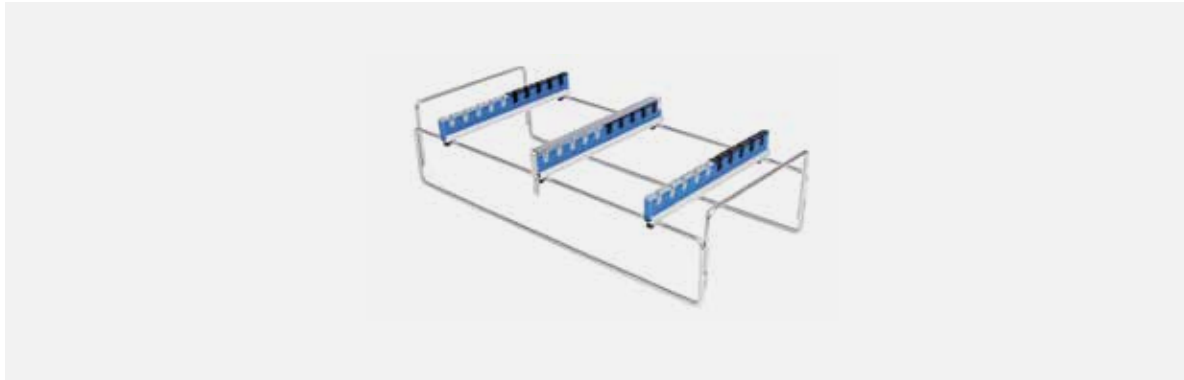

Code	Outside Dimension
K3-1090	502 x 255 x 130 mm

Code	Outside Dimension
K3-1093	555 x 255 x 130 mm

Rack, for endoscopy

- Holds 10 endoscopic instruments
- Fits into a 1/1 size 20 cm deep container
- Wire basket 1/1 50 mm
- Container 1/1 200 mm
- Silicone mat 520 x 230 mm

Rack, for endoscopy

- Holds 10 endoscopic instruments
- Fits into a Extra Long size 18 cm deep container
- Wire basket Extra Long 50 mm
- Container Extra Long 180 mm
- Silicone mat 340x230 (2pcs)



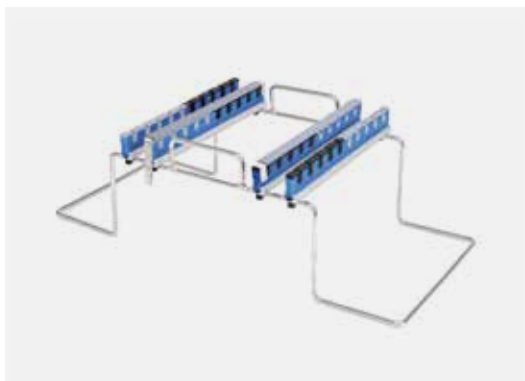

Code	Outside Dimension
K3-1092	515 x 250 x 165 mm

Rack, for arthroscopy

- Holds 20 arthroscopy punches
- Fits into a 1/1 size 20 cm deep container
- Wire basket 1/1 50 mm
- Container 1/1 200 mm
- Silicone mat 440 x 230 mm

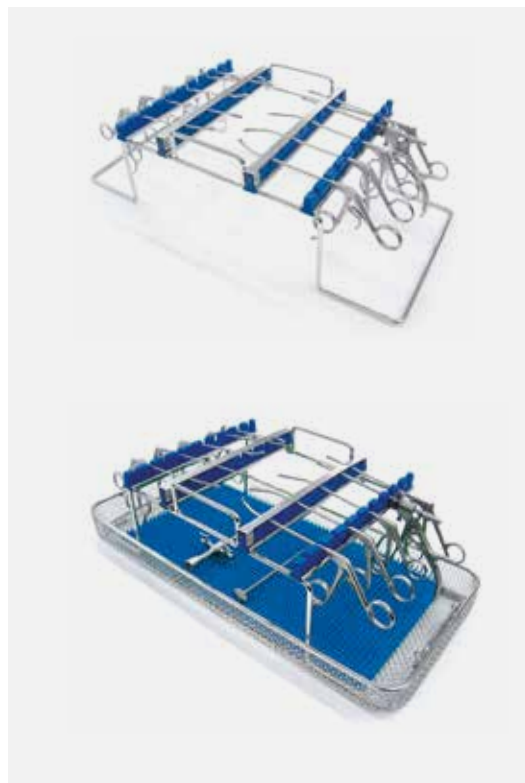

Code	Outside Dimension
K3-1094	220 x 250 x 160 mm



Rack, for Kerrison

- Holds 10 Kerrison punches
- Fits into a 1/2, 1/1 20 cm and Extra Long size 18 cm deep container
- Wire basket 1/2 50 mm
- Wire basket 1/1 50 mm
- Wire basket Extra long 50 mm
- Container 1/2 200 mm
- Container 1/1 200 mm
- Container Extra long 180 mm

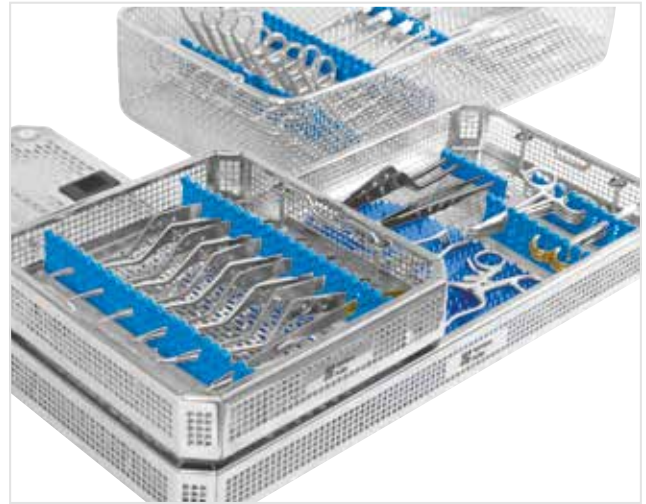



Code	Lenght
K1-1601	250 x 9 mm
K1-1602	158 x 9 mm
K1-1603	123 x 9 mm
K1-1604	97 x 9 mm
K1-1605	73 x 9 mm
K1-1606	23,5 x 9 mm

Code	
K1-680-02 (1 Piece)	 Kep nut
K1-680-03 (1 Piece)	 Screw

Can be manufactured in any size demanded



With rail, screw and nut

Code	Lenght	Height
K12-100	250 mm	45 mm
K12-101	152 mm	45 mm
K12-102	125 mm	45 mm
K12-145	97 mm	45 mm

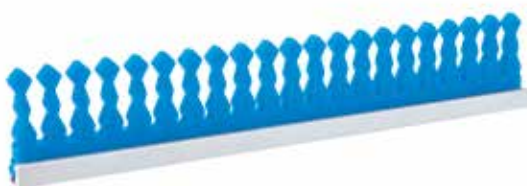
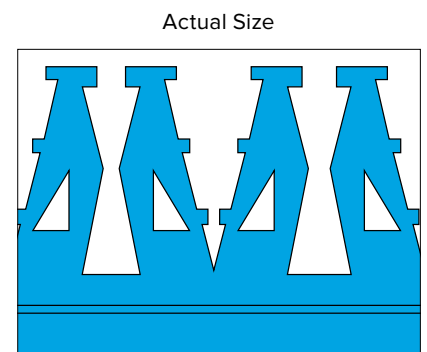

With rail, screw and nut

Code	Lenght	Height
K12-109	238 mm	45 mm
K12-110	158 mm	45 mm
K12-111	112 mm	45 mm
K12-148	77 mm	45 mm

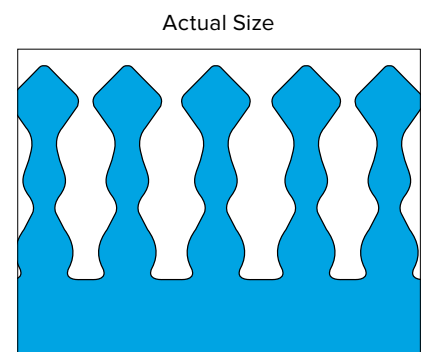



With rail, screw and nut

Code	Length	Height
K12-106	238 mm	45 mm
K12-107	150 mm	45 mm
K12-108	119 mm	45 mm
K12-147	87 mm	45 mm

Actual Size

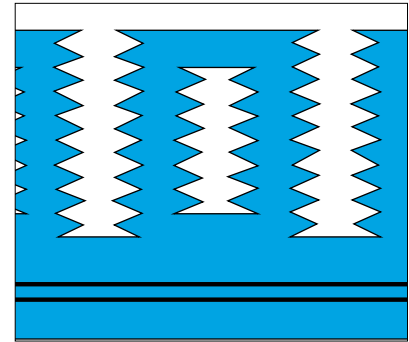

With rail, screw and nut

Code	Length	Height
K12-103	240 mm	45 mm
K12-104	150 mm	45 mm
K12-105	120 mm	45 mm
K12-146	90 mm	45 mm

Actual Size

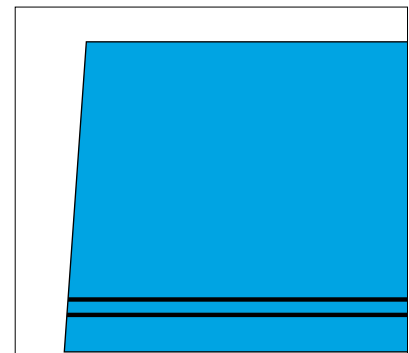

Instruments holder,
from Ø 3 to 8 mm
With rail, screw and nut

Code	Length	Height
K12-112	178 mm	24 mm

Actual Size

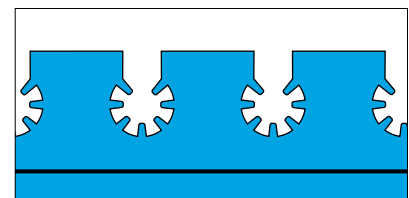

Code	Length	Height
K12-113	73 mm	24 mm

Instruments holder, Ø 5 mm
With rail, screw and nut

Actual Size

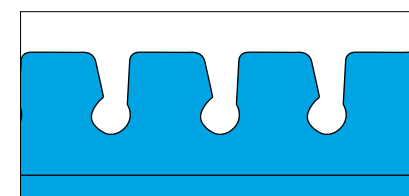



Instruments holder, Ø 3 mm
With rail, screw and nut

Code	Lenght	Height
K12-114	73 mm	24 mm

Actual Size

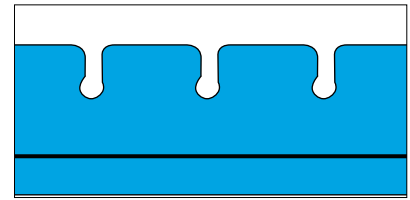

Instruments holder, from Ø 3 to 15 mm
With rail, screw and nut

Code	Lenght	Height
K12-115	178 mm	34 mm

Actual Size

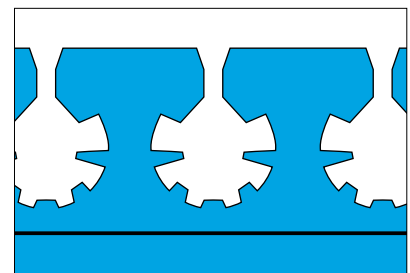

With rail, screw and nut

Code	Lenght	Height
K12-116	121 mm	22 mm

Actual Size

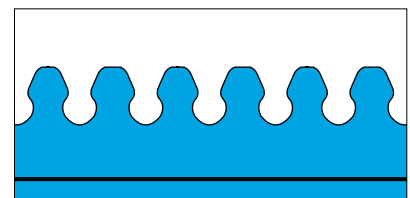

With rail, screw and nut

Code	Lenght	Height
K12-117	123 mm	22 mm

Actual Size

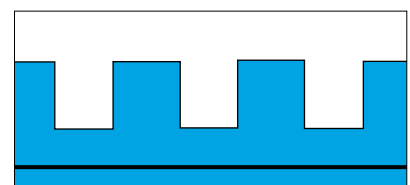

Instruments holder, from Ø 3 mm
With rail, screw and nut

Code	Lenght	Height
K12-124	178 mm	24 mm

Actual Size

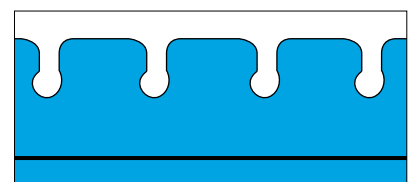



Instruments holder, Ø 5 mm
With rail, screw and nut

Code	Length	Height
K12-125	178 mm	24 mm

Actual Size

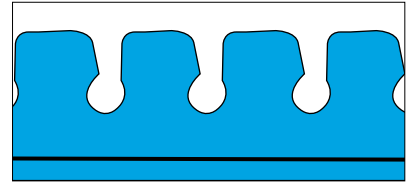

Code	Length	Height
K12-142	40 mm	25 mm

Actual Size

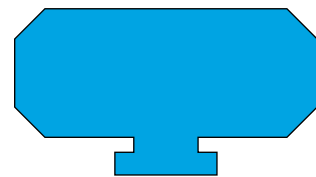

Code	Length	Height
K12-126	23.5 mm	25 mm

Ø 10,5 mm With rail, screw and nut

Actual Size

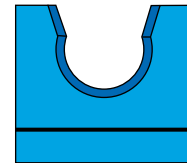

Code	Length	Height
K12-127	23.5 mm	25 mm

Ø 8 mm With rail, screw and nut

Actual Size

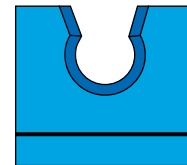

Code	Length	Height
K12-128	23.5 mm	25 mm

Ø 13 mm With rail, screw and nut

Actual Size

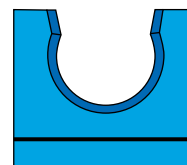

Code	Length	Height
K12-129	23.5 mm	25 mm

Ø 5 mm With rail, screw and nut

Actual Size

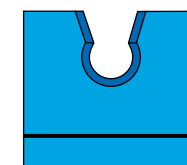



Code	Length	Height
K12-130	72 mm	34 mm

Endoscope holder, double
One side Ø 12 mm open
One side from Ø 3 to Ø 15 mm
closed With rail, screw and nut

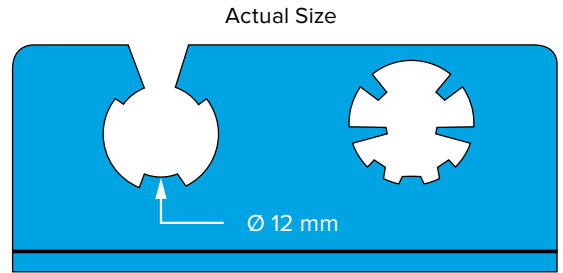

Code	Length	Height
K12-141	72 mm	34 mm

Endoscope holder, double
One side Ø 12 mm open
One side from Ø 3 to Ø 8 mm closed
With rail, screw and nut

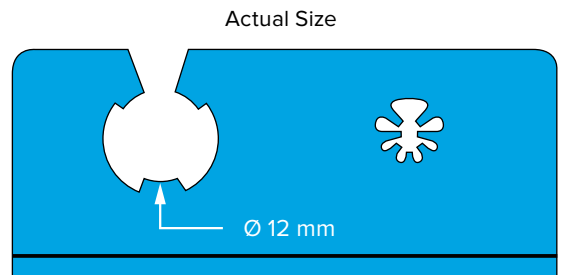

Code	Length	Height
K12-131	72 mm	34 mm

Instruments holder from Ø 3 to Ø 15 mm
With rail, screw and nut

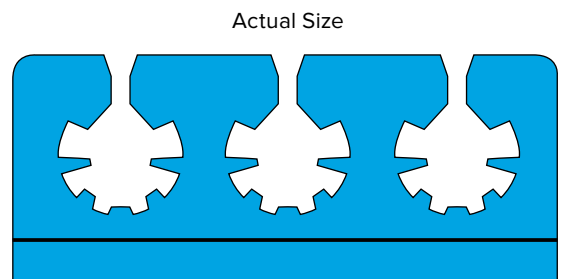

Code	Length	Height
K12-132	72 mm	24 mm

Instruments holder, from Ø 3 to Ø 8 mm
With rail, screw and nut

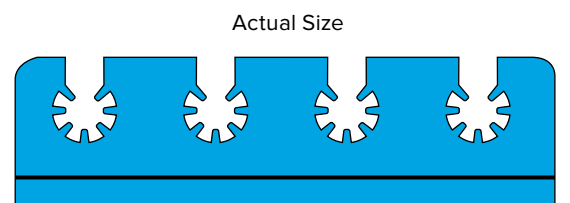

Code	Length	Height
K12-133	38 mm	24 mm

Endoscope holder, double one side
from Ø 3 to Ø 8 mm
With rail, screw and nut

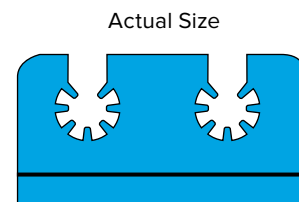

Code	Length	Height
K12-134	28 mm	34 mm

Endoscope holder, single one side Ø 12 mm
open one side from Ø 3 to
Ø 15 mm With rail, screw and nut

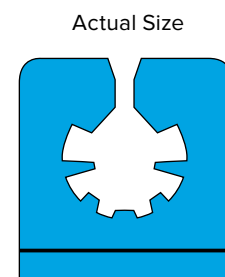



Code	Lenght	Height
K12-135	38 mm	33 mm

Endoscope holder, Ø 4 mm closed
With rail, screw and nut

Actual Size

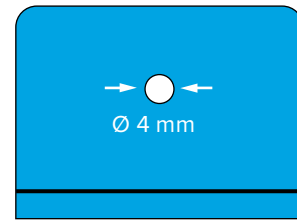

Code	Lenght	Height
K12-136	38 mm	33 mm

Endoscope holder, Ø 6 mm closed
With rail, screw and nut

Actual Size

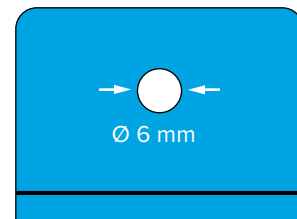

Code	Lenght	Height
K12-137	38 mm	33 mm

Endoscope holder, Ø 8 mm closed
With rail, screw and nut

Actual Size

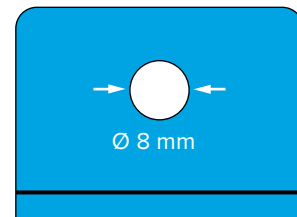

Code	Lenght	Height
K12-138	38 mm	33 mm

Endoscope holder, Ø 12 mm closed
With rail, screw and nut

Actual Size

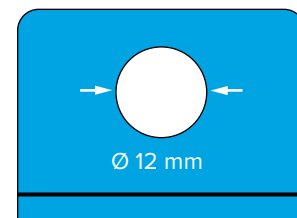

Code	Lenght	Height
K12-139	38 mm	33 mm

Endoscope holder, Ø 12 mm closed
With rail, screw and nut

Actual Size

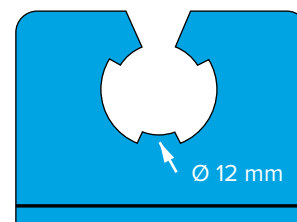

Code	Lenght	Height
K12-140	38 mm	33 mm

Endoscope holder, Ø 15 mm closed
With rail, screw and nut

Actual Size

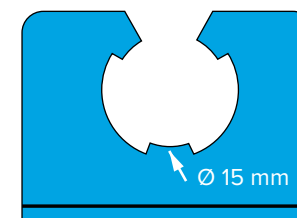



K2-650

Holding pin for divider



K2-651

Holding pin for instruments



K2-588

Fixation clamp

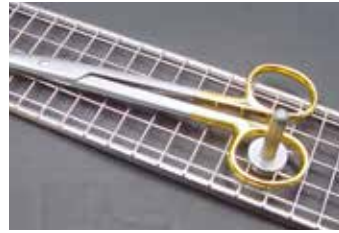

K2-645

DIVIDER
50 x 20 mm

K2-646

DIVIDER
130 x 20 mm

K2-647

DIVIDER
225 x 20 mm

K2-648

DIVIDER
460 x 20 mm

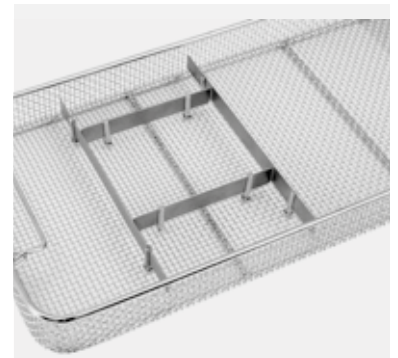

HOLDERS & DIVIDERS



K2-580
Ø 7 - 12 mm



K2-581
Ø 12 - 16 mm



K2-582
Ø 16 - 26 mm



K2-583
Ø 26 - 36 mm



K2-584
Ø 36 - 45 mm



Code **Outside Dimension**

K8-490 218 x 45 x 52 mm

Tilttable holding device for 6 micro heads

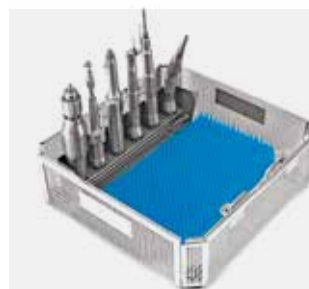



Code	Outside Dimension
------	-------------------

K2-600	40 x 5 x 18 mm
--------	----------------

DIVIDER (use with K2-601 and K2-602)



Code	Outside Dimension
------	-------------------

K2-601	230 x 26 mm
--------	-------------

K2-602	470 x 26 mm
--------	-------------

Sliding rails with securing screws



Code	Outside Dimension
------	-------------------

K2-604	230 x 26 mm
--------	-------------

K2-605	470 x 26 mm
--------	-------------

Limiting bar, with security screws



Code	Outside Dimension
------	-------------------

K2-607	233 x 30 mm
--------	-------------

Spiral holding device

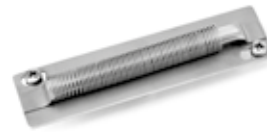

Code	Outside Dimension
------	-------------------

K2-609	116 x 30 mm
--------	-------------

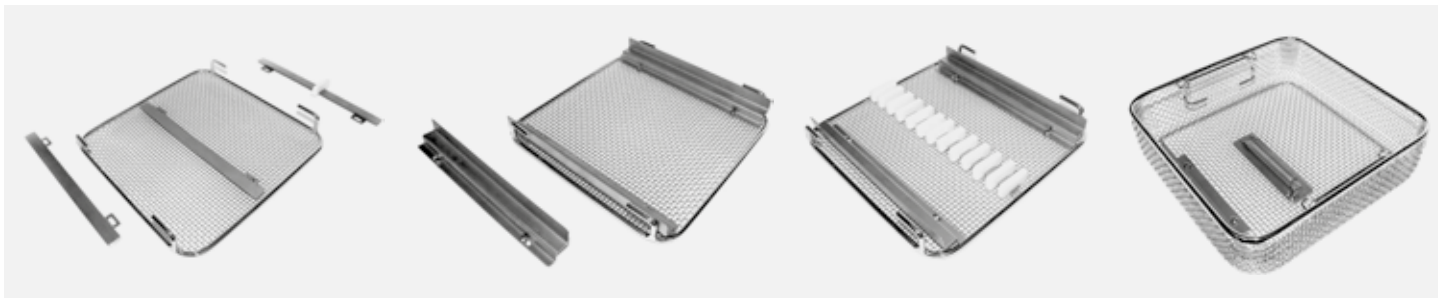

Code	Outside Dimension
------	-------------------

K2-615	112 x 18 mm
--------	-------------

K2-616	172 x 18 mm
--------	-------------

K2-617	232 x 18 mm
--------	-------------

K2-618	472 x 18 mm
--------	-------------

Limiting bar



Code	Outside Dimension
------	-------------------

K2-622	233 x 30 mm
--------	-------------

Spiral holding



Code	Outside Dimension
------	-------------------

K2-625	126 x 30 mm
--------	-------------

Spiral holding

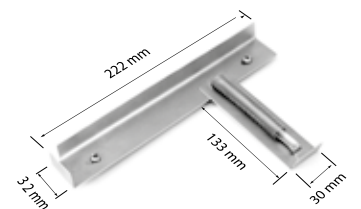

Code	K2-620
------	--------

Spiral holding



INDEX

Code	Page	Code	Page	Code	Page	Code	Page
K1-680-02	126	K2-582	132	K2-1500	100	K3-781	99
K1-680-03	126	K2-583	132	K2-1501	100	K3-781K	99
K1-900	110	K2-584	132	K2-1502	100	K3-782	99
K1-970	48, 50, 52	K2-588	132	K2-1503	100	K3-783K	99
K1-980	48, 50, 52	K2-600	133	K2-1522	103	K3-784K	99
K1-990A	48, 50, 52	K2-601	133	K2-1701	101	K3-785	99
K1-995	48, 50, 52	K2-602	133	K2-1702	101	K3-785K	99
K1-1601	126	K2-604	133	K2-1703	101	K3-786	98
K1-1602	126	K2-605	133	K2-1715	121	K3-786K	98
K1-1603	126	K2-607	133	K2-1716	121	K3-787	98
K1-1604	126	K2-609	133	K2-1717	121	K3-788	98
K1-1605	126	K2-615	133	K2-1718	121	K3-789	98
K1-1606	126	K2-616	133	K2-1801	101	K3-790K	98
K2-440	103	K2-617	133	K2-1802	101	K3-791K	98
K2-450	101	K2-618	133	K2-1803	101	K3-792K	98
K2-451	101	K2-620	133	K3-611	102	K3-793K	98
K2-452	101	K2-622	133	K3-612	120	K3-948	123
K2-453	101	K2-625	133	K3-615	120	K3-949	123
K2-460	101	K2-645	132	K3-615Z	118	K3-950	123
K2-461	101	K2-646	132	K3-705	95	K3-951	123
K2-462	101	K2-647	132	K3-706	95	K3-952	123
K2-463	101	K2-648	132	K3-707	95	K3-953	123
K2-482	103	K2-650	132	K3-708	95	K3-954	123
K2-490	100	K2-651	132	K3-709	95	K3-955	123
K2-491	100	K2-660	118	K3-710	95	K3-956	123
K2-492	100	K2-661	118	K3-711	95	K3-957	123
K2-493	100	K2-662	118	K3-712	95	K3-958	123
K2-519	122	K2-663	118	K3-713	95	K3-1014	101
K2-520	122	K2-663Z	118	K3-714	95	K3-1024	101
K2-521	122	K2-664	118	K3-740	93	K3-1034	100
K2-522	122	K2-665	118	K3-741	93	K3-1045	100
K2-523	122	K2-672	117	K3-742	93	K3-1050	106
K2-524	122	K2-672Z	118	K3-743	93	K3-1051	106
K2-525	122	K2-673	117	K3-744	93	K3-1052	106
K2-526	122	K2-673Z	118	K3-745	93	K3-1054	106
K2-527	122	K2-700	117	K3-746	93	K3-1055	106
K2-528	122	K2-701	117	K3-747	93	K3-1062	106
K2-529	122	K2-702	117	K3-748	94	K3-1070	102
K2-530	122	K2-703	117	K3-749	94	K3-1073	102
K2-531	122	K2-704	117	K3-750	94	K3-1079	102
K2-532	122	K2-705	117	K3-751	94	K3-1080	104
K2-533	122	K2-706	117	K3-752	94	K3-1081	104
K2-534	122	K2-707	117	K3-753	94	K3-1085	104
K2-535	122	K2-720	121	K3-754	94	K3-1086	104
K2-536	122	K2-740	119	K3-755	94	K3-1090	124
K2-560	117	K2-741	119	K3-756	96	K3-1092	125
K2-561	117	K2-741Z	118	K3-757	96	K3-1093	124
K2-562	117	K2-742	119	K3-758	96	K3-1094	125
K2-563	117	K2-743	120	K3-760	93	K3-1100	103
K2-564	117	K2-744	120, 121	K3-761	93	K3-1101	103
K2-565	117	K2-745	119	K3-762	94	K3-1102	103
K2-566	117	K2-758	121	K3-763	94	K3-1103	103
K2-567	117	K2-759	121	K3-764	96	K3-1104	103
K2-570	117	K2-759Z	118	K3-765	96	K3-1105	103
K2-571	117	K2-760	120	K3-766	96	K3-1106	103
K2-572	117	K2-761	120	K3-767	96	K3-1107	103
K2-573	117	K2-761Z	118	K3-768	96	K3-1108	103
K2-574	117	K2-780	120	K3-770	96	K3-1109	103
K2-575	117	K2-780Z	118	K3-771	96	K3-1110	103
K2-576	117	K2-781	120	K3-772	96	K3-1111	103
K2-577	117	K2-782	120	K3-773	96	K3-1112	103
K2-580	132	K2-993	102	K3-780	99	K3-1113	103
K2-581	132	K2-995	102	K3-780K	99	K3-1114	103

Code	Page	Code	Page	Code	Page	Code	Page
K3-1115	103	K5-035	88	K5-108	91	K5-239	89
K3-1116	103	K5-036	88	K5-109	91	K5-240	89
K3-1117	103	K5-037	88	K5-110	91	K5-241	89
K3-1118	103	K5-038	88	K5-111	91	K5-242	89
K3-1119	107	K5-039	88	K5-115	91	K5-243	89
K3-1120	107	K5-040	88	K5-116	91	K5-244	89
K3-1121	107	K5-041	88	K5-117	91	K5-245	89
K3-1200	104	K5-042	88	K5-118	91	K5-246	89
K3-1201	104	K5-043	88	K5-119	91	K5-247	89
K3-1202	104	K5-044	88	K5-120	91	K6-100	18
K3-1203	104	K5-045	88	K5-121	91	K6-100D	61
K3-1204	104	K5-048	88	K5-122	91	K6-100Z	69
K3-1205	104	K5-049	88	K5-123	91	K6-101	18
K3-1206	105	K5-050	88	K5-124	91	K6-101D	61
K3-1207	105	K5-051	88	K5-125	91	K6-101Z	69
K3-1208	105	K5-052	88	K5-126	91	K6-102	18
K3-1210	105	K5-053	88	K5-127	91	K6-102D	61
K3-1211	105	K5-054	88	K5-128	91	K6-102Z	69
K3-1230	105	K5-055	88	K5-129	91	K6-103	18
K3-1231	105	K5-056	88	K5-130	91	K6-103D	61
K3-1232	105	K5-057	88	K5-131	91	K6-104	18
K3-1233	105	K5-058	88	K5-132	91	K6-104D	61
K3-1234	105	K5-059	88	K5-133	91	K6-105	18, 32, 48
K3-1235	105	K5-060	90	K5-134	91	K6-106	18, 32, 48
K3-1236	105	K5-061	90	K5-200	89	K6-107	18, 32, 48
K3-1237	105	K5-062	90	K5-201	89	K6-108	18, 32, 48
K3-1238	105	K5-063	90	K5-202	89	K6-109	18, 32, 48
K3-1239	105	K5-064	90	K5-203	89	K6-120D	61
K3-1240	105	K5-065	90	K5-204	89	K6-120Z	69
K3-1241	105	K5-066	90	K5-205	89	K6-121D	61
K3-1707	101	K5-067	90	K5-206	89	K6-122D	61
K3-1807	101	K5-068	90	K5-207	89	K6-123D	61
K3-2000	101	K5-069	90	K5-208	89	K6-124D	61
K3-2001	101	K5-070	90	K5-209	89	K6-125D	61
K3-2002	101	K5-071	90	K5-210	89	K6-126D	61
K3-2013	101	K5-072	90	K5-211	89	K6-127D	61
K4-1051	108	K5-073	90	K5-212	89	K6-230	49
K4-1052	108	K5-074	90	K5-213	89	K6-231	49
K5-010	88	K5-075	90	K5-214	89	K6-232	49
K5-011	88	K5-076	90	K5-215	89	K6-233	49
K5-012	88	K5-077	90	K5-216	89	K6-234	49
K5-013	88	K5-078	90	K5-217	89	K6-235	49
K5-014	88	K5-079	90	K5-218	89	K6-236	49
K5-015	88	K5-080	90	K5-219	89	K6-237	49
K5-016	88	K5-081	90	K5-220	89	K6-300	20
K5-017	88	K5-082	90	K5-221	89	K6-300D	63
K5-018	88	K5-083	90	K5-222	89	K6-300Z	69
K5-019	88	K5-084	90	K5-223	89	K6-301	20
K5-020	88	K5-085	90	K5-224	89	K6-301D	63
K5-021	88	K5-086	90	K5-225	89	K6-301Z	69
K5-022	88	K5-087	90	K5-226	89	K6-302	20
K5-023	88	K5-088	90	K5-227	89	K6-302D	63
K5-024	88	K5-089	90	K5-228	89	K6-302Z	69
K5-025	88	K5-090	90	K5-229	89	K6-303	20
K5-026	88	K5-091	90	K5-230	89	K6-303D	63
K5-027	88	K5-100	91	K5-231	89	K6-303Z	69
K5-028	88	K5-101	91	K5-232	89	K6-305	20, 34, 50
K5-029	88	K5-102	91	K5-233	89	K6-306	20, 34, 50
K5-030	88	K5-103	91	K5-234	89	K6-307	20, 34, 50
K5-031	88	K5-104	91	K5-235	89	K6-308	20, 34, 50
K5-032	88	K5-105	91	K5-236	89	K6-340D	63
K5-033	88	K5-106	91	K5-237	89	K6-340Z	69
K5-034	88	K5-107	91	K5-238	89	K6-341D	63

INDEX

Code	Page	Code	Page	Code	Page	Code	Page
K6-342D	63	K6-1100Z	73	K6-1781	87	K6-1982	85
K6-343D	63	K6-1101	82	K6-1782	87	K6-1983	85
K6-344D	63	K6-1101Z	73	K6-1783	87	K6-1984	85
K6-345D	63	K6-1105	82	K6-1784	87	K6-1985	85
K6-346D	63	K6-1106	82	K6-1785	87	K6-1986	85
K6-347D	63	K6-1418	87	K6-1786	87	K6-1987	85
K6-400	24	K6-1419	87	K6-1787	87	K6-2000	26
K6-401	24	K6-1420	87	K6-1790	87	K6-2001	26
K6-402	24, 38, 54	K6-1421	87	K6-1791	87	K6-2002	26
K6-403	24, 38, 54	K6-1422	87	K6-1792	87	K6-2005	26, 40, 56
K6-410	51	K6-1423	87	K6-1793	87	K6-2006	26, 40, 56
K6-411	51	K6-1424	87	K6-1794	87	K6-2007	26, 40, 56
K6-412	51	K6-1425	87	K6-1795	87	K6-3120	19
K6-413	51	K6-1560	80	K6-1796	87	K6-3121	19
K6-414	51	K6-1560Z	71	K6-1797	87	K6-3122	19
K6-415	51	K6-1561	80	K6-1860	78	K6-3123	19
K6-416	51	K6-1561Z	71	K6-1860Z	71	K6-3124	19
K6-417	51	K6-1562	80	K6-1861	78	K6-3125	19
K6-600	22	K6-1562Z	71	K6-1861Z	71	K6-3126	19
K6-600D	65	K6-1565	80	K6-1862	78	K6-3127	19
K6-600Z	69	K6-1566	80	K6-1862Z	71	K6-3128	19
K6-601	22	K6-1567	80	K6-1863	78	K6-3129	19
K6-601D	65	K6-1570	81	K6-1865	78	K6-3130	19
K6-601Z	69	K6-1570Z	71	K6-1866	78	K6-3131	19
K6-602	22	K6-1571	81	K6-1867	78	K6-3132	19
K6-602D	65	K6-1572	81	K6-1868	78	K6-3133	19
K6-602Z	69	K6-1573	81	K6-1870	79	K6-3134	19
K6-603	22	K6-1574	81	K6-1871	79	K6-3135	19
K6-603D	65	K6-1575	81	K6-1872	79	K6-3230	19
K6-604	22	K6-1576	81	K6-1873	79	K6-3231	19
K6-604D	65	K6-1577	81	K6-1874	79	K6-3232	19
K6-605	22, 36, 52	K6-1580	81	K6-1875	79	K6-3233	19
K6-606	22, 36, 52	K6-1581	81	K6-1876	79	K6-3234	19
K6-607	22, 36, 52	K6-1582	81	K6-1877	79	K6-3235	19
K6-608	22, 36, 52	K6-1583	81	K6-1880	79	K6-3236	19
K6-609	22, 36, 52	K6-1584	81	K6-1880Z	71	K6-3237	19
K6-630D	65	K6-1585	81	K6-1881	79	K6-3315	25
K6-630Z	69	K6-1586	81	K6-1882	79	K6-3316	25
K6-631D	65	K6-1587	81	K6-1883	79	K6-3320	21
K6-632D	65	K6-1665	76	K6-1884	79	K6-3321	21
K6-633D	65	K6-1666	76	K6-1885	79	K6-3322	21
K6-634D	65	K6-1667	76	K6-1886	79	K6-3323	21
K6-635D	65	K6-1680	77	K6-1887	79	K6-3324	21
K6-636D	65	K6-1681	77	K6-1960	84	K6-3325	21
K6-637D	65	K6-1682	77	K6-1960Z	71	K6-3326	25
K6-700	53	K6-1683	77	K6-1961	84	K6-3327	25
K6-701	53	K6-1684	77	K6-1961Z	71	K6-3328	25
K6-702	53	K6-1685	77	K6-1962	84	K6-3329	25
K6-703	53	K6-1686	77	K6-1962Z	71	K6-3330	25
K6-704	53	K6-1687	77	K6-1965	84	K6-3331	25
K6-705	53	K6-1690	77	K6-1966	84	K6-3332	25
K6-706	53	K6-1691	77	K6-1967	84	K6-3333	25
K6-707	53	K6-1692	77	K6-1970	85	K6-3334	25
K6-1000	83	K6-1693	77	K6-1970Z	71	K6-3335	25
K6-1000Z	73	K6-1694	77	K6-1971	85	K6-3336	25
K6-1001	83	K6-1695	77	K6-1972	85	K6-3337	25
K6-1002	83	K6-1696	77	K6-1973	85	K6-3338	25
K6-1003	83	K6-1697	77	K6-1974	85	K6-3339	25
K6-1004	83	K6-1770	86	K6-1975	85	K6-3340	21
K6-1005	83	K6-1771	86	K6-1976	85	K6-3341	21
K6-1006	83	K6-1775	86	K6-1977	85	K6-3342	21
K6-1007	83	K6-1776	86	K6-1980	85	K6-3343	21
K6-1100	82	K6-1780	87	K6-1981	85	K6-3344	21

Code	Page	Code	Page	Code	Page	Code	Page
K6-3345	21	K7-125	33	K7-1419	87	K8-101P	48
K6-3346	21	K7-126	33	K7-1420	87	K8-101V	48
K6-3347	21	K7-127	33	K7-1421	87	K8-102B	48
K6-3348	21	K7-300	34	K7-1422	87	K8-102BA	48
K6-3349	21	K7-301	34	K7-1423	87	K8-102P	48
K6-3370	27	K7-302	34	K7-1424	87	K8-102V	48
K6-3371	27	K7-303	34	K7-1425	87	K8-103B	48
K6-3372	27	K7-315	39	K7-1680	77	K8-103BA	48
K6-3373	27	K7-316	39	K7-1681	77	K8-103P	48
K6-3374	27	K7-326	39	K7-1682	77	K8-103V	48
K6-3375	27	K7-327	39	K7-1683	77	K8-104B	48
K6-3376	27	K7-328	39	K7-1684	77	K8-104BA	48
K6-3377	27	K7-329	39	K7-1685	77	K8-104P	48
K6-3380	27	K7-330	39	K7-1686	77	K8-104V	48
K6-3381	27	K7-331	39	K7-1687	77	K8-120B	49
K6-3382	27	K7-340	35	K7-1770	86	K8-120BA	49
K6-3383	27	K7-341	35	K7-1771	86	K8-120P	49
K6-3384	27	K7-342	35	K7-1780	87	K8-120V	49
K6-3385	27	K7-343	35	K7-1781	87	K8-121B	49
K6-3386	27	K7-344	35	K7-1782	87	K8-121BA	49
K6-3387	27	K7-345	35	K7-1783	87	K8-121P	49
K6-3410	21	K7-346	35	K7-1784	87	K8-121V	49
K6-3411	21	K7-347	35	K7-1785	87	K8-122B	49
K6-3412	21	K7-400	33	K7-1786	87	K8-122BA	49
K6-3413	21	K7-401	33	K7-1787	87	K8-122P	49
K6-3414	21	K7-402	33	K7-1861	78	K8-122V	49
K6-3415	21	K7-403	33	K7-1862	78	K8-123B	49
K6-3416	21	K7-404	33	K7-1863	78	K8-123BA	49
K6-3417	21	K7-405	33	K7-1880	79	K8-123P	49
K6-3620	23	K7-406	35	K7-1881	79	K8-123V	49
K6-3621	23	K7-407	35	K7-1882	79	K8-124B	49
K6-3622	23	K7-408	35	K7-1883	79	K8-124BA	49
K6-3623	23	K7-409	35	K7-1884	79	K8-124P	49
K6-3624	23	K7-410	35	K7-1885	79	K8-124V	49
K6-3625	23	K7-411	35	K7-1886	79	K8-125B	49
K6-3630	23	K7-412	37	K7-1887	79	K8-125BA	49
K6-3631	23	K7-413	37	K7-1961	84	K8-125P	49
K6-3632	23	K7-414	37	K7-1962	84	K8-125V	49
K6-3633	23	K7-415	37	K7-1970	85	K8-126B	49
K6-3634	23	K7-416	37	K7-1971	85	K8-126BA	49
K6-3635	23	K7-417	37	K7-1972	85	K8-126P	49
K6-3636	23	K7-418	33	K7-1973	85	K8-126V	49
K6-3637	23	K7-419	33	K7-1974	85	K8-127B	49
K6-3638	23	K7-420	35	K7-1975	85	K8-127BA	49
K6-3639	23	K7-421	35	K7-1976	85	K8-127P	49
K6-3700	23	K7-422	37	K7-1977	85	K8-127V	49
K6-3701	23	K7-423	37	K7-2000	40	K8-300B	50
K6-3702	23	K7-600	36	K7-2001	40	K8-300BA	50
K6-3703	23	K7-601	36	K7-2002	40	K8-300P	50
K6-3704	23	K7-602	36	K7-2120	41	K8-300V	50
K6-3705	23	K7-603	36	K7-2121	41	K8-301B	50
K6-3706	23	K7-604	36	K7-2122	41	K8-301BA	50
K6-3707	23	K7-630	37	K7-2123	41	K8-301P	50
K7-100	32	K7-631	37	K7-2124	41	K8-301V	50
K7-101	32	K7-632	37	K7-2125	41	K8-302B	50
K7-102	32	K7-633	37	K7-2126	41	K8-302BA	50
K7-103	32	K7-634	37	K7-2127	41	K8-302P	50
K7-104	32	K7-635	37	K8-100B	48	K8-302V	50
K7-120	33	K7-636	37	K8-100BA	48	K8-303B	50
K7-121	33	K7-637	37	K8-100P	48	K8-303BA	50
K7-122	33	K7-700	38	K8-100V	48	K8-303P	50
K7-123	33	K7-701	38	K8-101B	48	K8-303V	50
K7-124	33	K7-1418	87	K8-101BA	48	K8-315B	55

INDEX

Code	Page	Code	Page	Code	Page	Code	Page
K8-315BA	55	K8-490	132	K8-2000P	56	K12-127	129
K8-315P	55	K8-600B	52	K8-2000V	56	K12-128	129
K8-315V	55	K8-600BA	52	K8-2001B	56	K12-129	129
K8-316B	55	K8-600P	52	K8-2001BA	56	K12-130	130
K8-316BA	55	K8-600V	52	K8-2001P	56	K12-131	130
K8-316P	55	K8-601B	52	K8-2001V	56	K12-132	130
K8-316V	55	K8-601BA	52	K8-2002B	56	K12-133	130
K8-326B	55	K8-601P	52	K8-2002BA	56	K12-134	130
K8-326BA	55	K8-601V	52	K8-2002P	56	K12-135	131
K8-326P	55	K8-602B	52	K8-2002V	56	K12-136	131
K8-326V	55	K8-602BA	52	K8-2120B	57	K12-137	131
K8-327B	55	K8-602P	52	K8-2120BA	57	K12-138	131
K8-327BA	55	K8-602V	52	K8-2120P	57	K12-139	131
K8-327P	55	K8-603B	52	K8-2120V	57	K12-140	131
K8-327V	55	K8-603BA	52	K8-2121B	57	K12-141	130
K8-328B	55	K8-603P	52	K8-2121BA	57	K12-142	129
K8-328BA	55	K8-603V	52	K8-2121P	57	K12-145	126
K8-328P	55	K8-604B	52	K8-2121V	57	K12-146	127
K8-328V	55	K8-604BA	52	K8-2122B	57	K12-147	127
K8-329B	55	K8-604P	52	K8-2122BA	57	K12-148	126
K8-329BA	55	K8-604V	52	K8-2122P	57	KA-100	109
K8-329P	55	K8-630B	53	K8-2122V	57	KB-100	109
K8-329V	55	K8-630BA	53	K8-2123B	57	KC-100	109
K8-330B	55	K8-630P	53	K8-2123BA	57	KLA-100	109
K8-330BA	55	K8-630V	53	K8-2123P	57	KLB-100	109
K8-330P	55	K8-631B	53	K8-2123V	57	KLC-100	109
K8-330V	55	K8-631BA	53	K8-2124B	57		
K8-331B	55	K8-631P	53	K8-2124BA	57		
K8-331BA	55	K8-631V	53	K8-2124P	57		
K8-331P	55	K8-632B	53	K8-2124V	57		
K8-331V	55	K8-632BA	53	K8-2125B	57		
K8-340B	51	K8-632P	53	K8-2125BA	57		
K8-340BA	51	K8-632V	53	K8-2125P	57		
K8-340P	51	K8-633B	53	K8-2125V	57		
K8-340V	51	K8-633BA	53	K8-2126B	57		
K8-341B	51	K8-633P	53	K8-2126BA	57		
K8-341BA	51	K8-633V	53	K8-2126P	57		
K8-341P	51	K8-634B	53	K8-2126V	57		
K8-341V	51	K8-634BA	53	K8-2127B	57		
K8-342B	51	K8-634P	53	K8-2127BA	57		
K8-342BA	51	K8-634V	53	K8-2127P	57		
K8-342P	51	K8-635B	53	K8-2127V	57		
K8-342V	51	K8-635BA	53	K12-100	126		
K8-343B	51	K8-635P	53	K12-101	126		
K8-343BA	51	K8-635V	53	K12-102	126		
K8-343P	51	K8-636B	53	K12-103	127		
K8-343V	51	K8-636BA	53	K12-104	127		
K8-344B	51	K8-636P	53	K12-105	127		
K8-344BA	51	K8-636V	53	K12-106	127		
K8-344P	51	K8-637B	53	K12-107	127		
K8-344V	51	K8-637BA	53	K12-108	127		
K8-345B	51	K8-637P	53	K12-109	126		
K8-345BA	51	K8-637V	53	K12-110	126		
K8-345P	51	K8-700B	54	K12-111	126		
K8-345V	51	K8-700BA	54	K12-112	127		
K8-346B	51	K8-700P	54	K12-113	127		
K8-346BA	51	K8-700V	54	K12-114	128		
K8-346P	51	K8-701B	54	K12-115	128		
K8-346V	51	K8-701BA	54	K12-116	128		
K8-347B	51	K8-701P	54	K12-117	128		
K8-347BA	51	K8-701V	54	K12-124	128		
K8-347P	51	K8-2000B	56	K12-125	129		
K8-347V	51	K8-2000BA	56	K12-126	129		



Headquarter

Hermann Müller Medizintechnik GmbH
Dr. Karl-Storz-Strasse 3 •
78532 Tuttlingen • Germany

T : +49 (0) 7461 4125
F : +49 (0) 7461 79263

Factory

Kerimbeyosb Mah.
Yaşardođu Cad. No: 76/1
55330, Tekkeköy/Samsun/Türkiye

www.hermannmuller.com
info@hermannmuller.com

All rights reserved. No part of this catalog may be reproduced, copied, or published in any form without the written permission of Hermann Müller.